

Our Policy toward Realization of “Co-Creative Chemical Company”

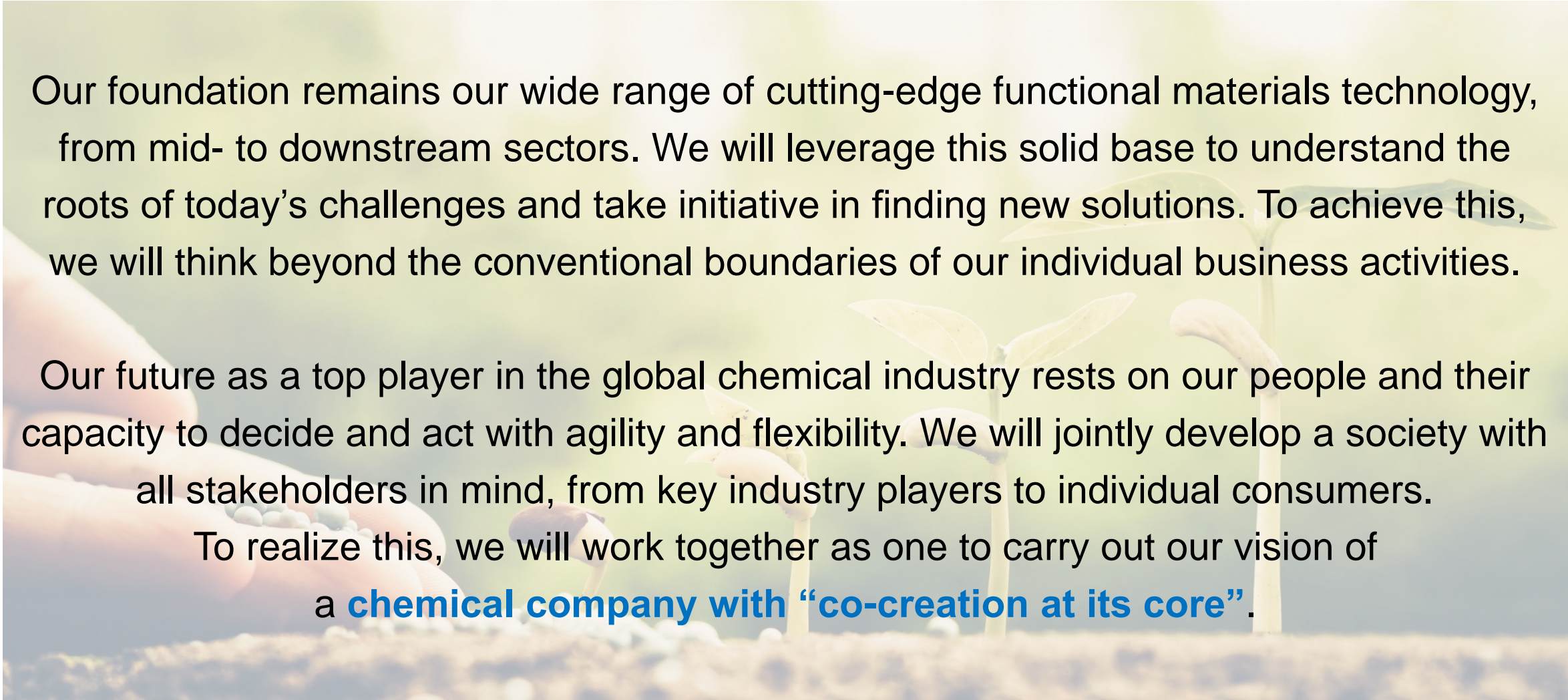

February 14, 2022
Hidehito Takahashi
President & CEO
SHOWA DENKO K.K.

What is Co-Creative Chemical Company?

A background image showing a pair of hands holding several small, light-colored seeds. In the foreground, several small green seedlings with two leaves each are growing out of a bed of brown soil. The background is a soft, out-of-focus green field under a bright sky.

Our foundation remains our wide range of cutting-edge functional materials technology, from mid- to downstream sectors. We will leverage this solid base to understand the roots of today's challenges and take initiative in finding new solutions. To achieve this, we will think beyond the conventional boundaries of our individual business activities.

Our future as a top player in the global chemical industry rests on our people and their capacity to decide and act with agility and flexibility. We will jointly develop a society with all stakeholders in mind, from key industry players to individual consumers.

To realize this, we will work together as one to carry out our vision of
a **chemical company with “co-creation at its core”**.

Intention of this announcement

This announcement is an update of the long-term vision announced in December 2020 with the start of the new management system and new management philosophy.

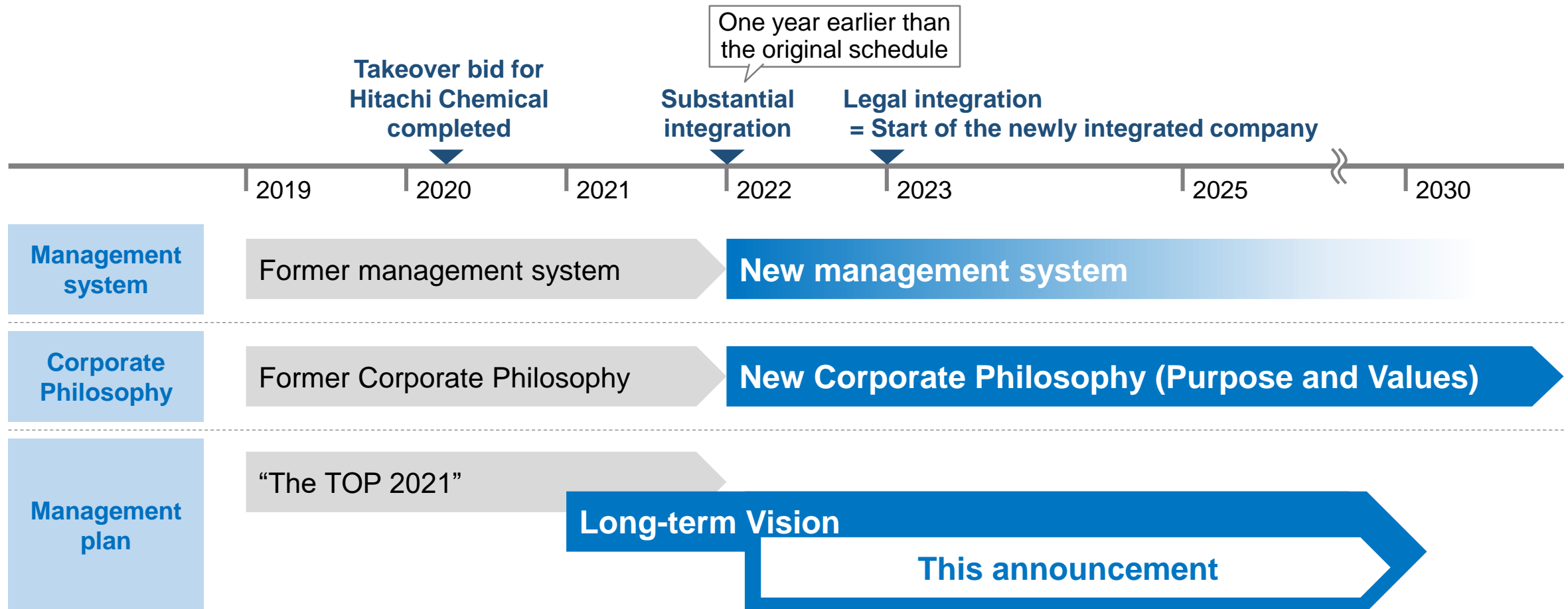



**Happiness and
prosperity of the
people**

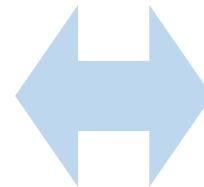

**Crisis of the global
environment**

Change society through the power of chemistry

~ Contribute to the sustainable development of global society
by creating functions required of the times as an advanced material partner ~

Ideal state of the newly integrated company

While taking advantage of the strength fostered as a Japanese chemical company, the newly integrated company aims to become a “Global Top-level functional chemical manufacturer” that solves various social issues by introducing advanced management style of global corporation.

“Global Top-level functional chemical manufacturer from Japan”

Company that can compete on the world stage

World-class competitiveness and profitability



Company that contributes to sustainable global society

Capability to create innovations and to develop new businesses



Company that develops talents that represents Japan's manufacturing industry

Power to train competitive talent with shared values



Newly integrated company's main strategies

To become global top-level functional chemical manufacturer, we will establish our “Platform”, and promote strategies of “Profitability”, “Portfolio management”, and “Innovation” .

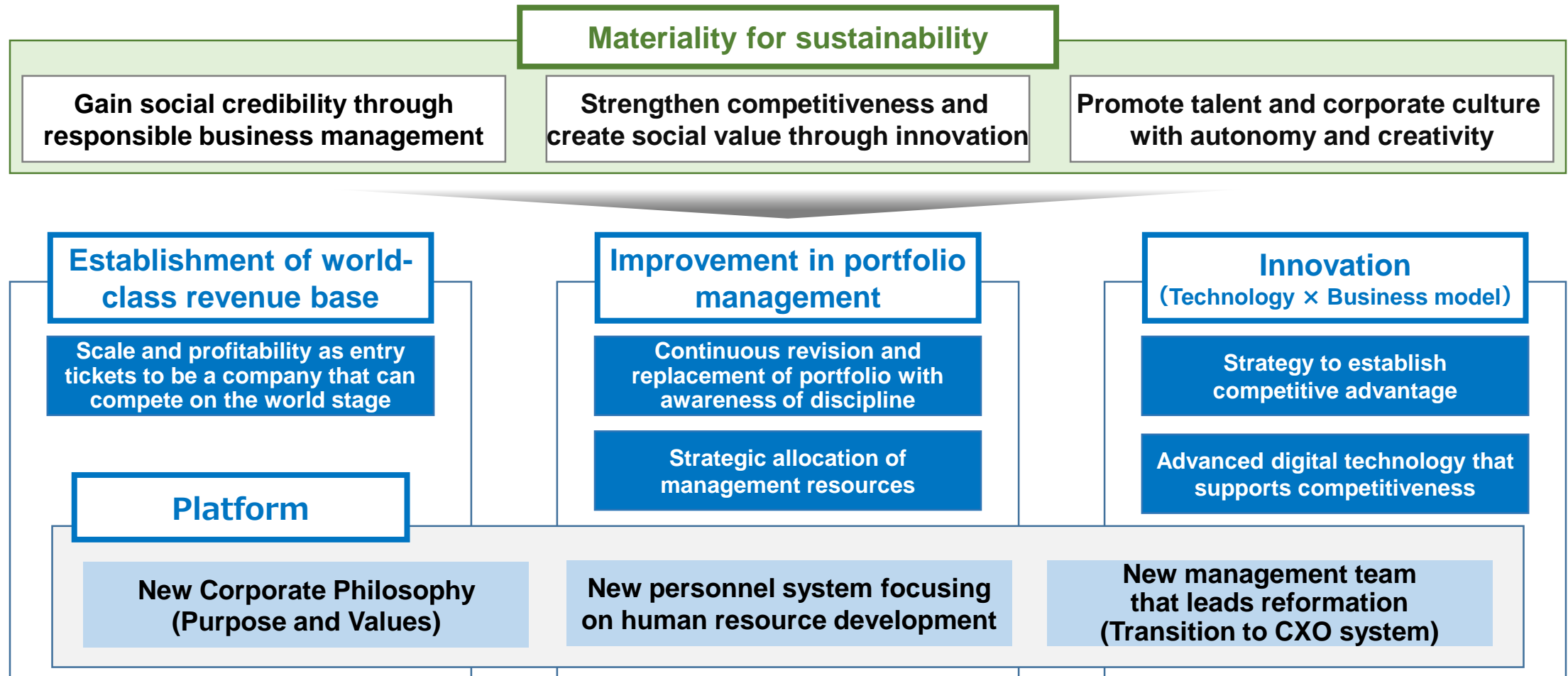

Our approach to sustainability

We set the idea of sustainability embedded in the Purpose, which is “Change society through the power of chemistry,” as a basis of our management. Thereby, realize sustainable growth and improve our corporate value through providing values for society.

Strengthen sustainability management

- As a newly integrated company, we redefine sustainability-related material issues, and set individual KPIs
- We incorporate viewpoint of sustainability into our business portfolio management and business/technology development
- We sincerely pursue carbon neutrality as a chemical company that has petrochemicals and chemicals businesses
- We foster mutual trust and create opportunities to co-create by strengthening stakeholder engagement
- We foster employees' sustainability mind on the basis of Purpose and Values

Contribute to sustainable society as Co-Creative Chemical Company

- We contribute to energy conservation and mitigation of environmental burden through supply of leading-edge materials for semiconductors and xEVs ,etc.



- We contribute to realize highly recycling-oriented society through development of recycling technology for materials



- We further promote innovation through co-creation aiming at solution of social issues

Establishment of world-class revenue base

Scale and profitability as entry tickets to be a company that can compete on the world stage



We will aim to maintain net sales of 1 trillion yen or more and EBITDA margin of 20% or more, which are necessary for us in order to maintain profitability high enough and the scale of business large enough to compete on the world stage.

Global chemical companies' scale of business and profitability

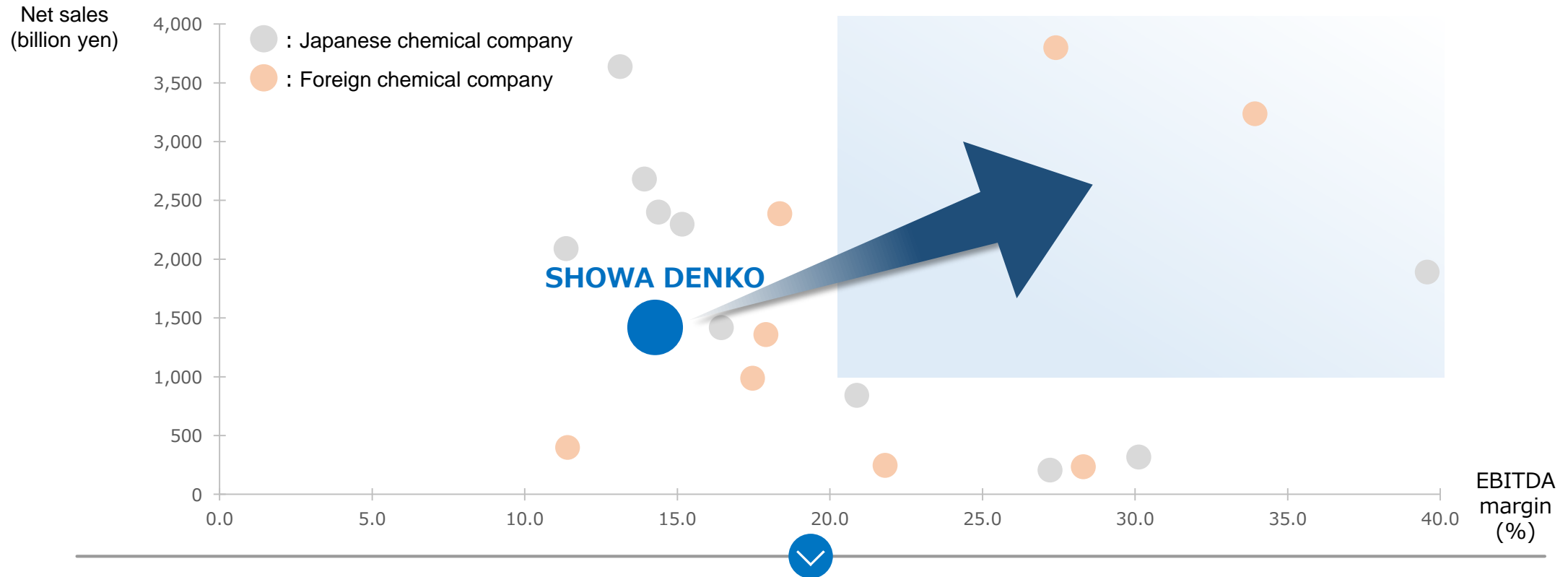

We will aim to become a global excellent company that can win international competition

Source: Financial results announced by chemical companies, and plotted by SDK

Continuous revision and replacement of portfolio with awareness of discipline

We will continue revising and replacing business portfolio. We will sophisticate business portfolio management further through business operation with awareness of discipline (profitability and capital efficiency), in addition to viewpoint of fitness for strategy and best owner.

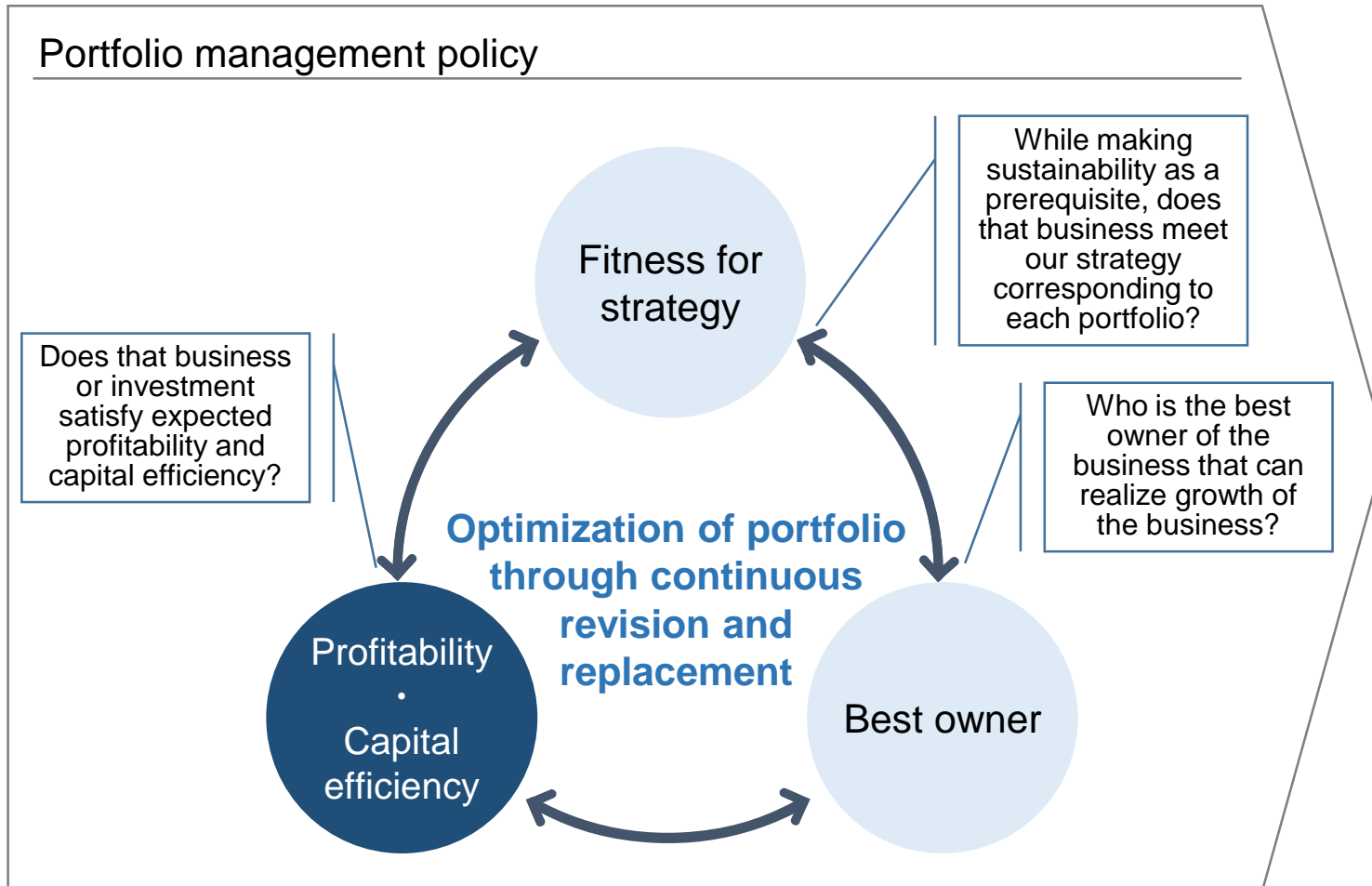

We will realize ROIC of 10% or more, and maximize our corporate value

Improvement in portfolio management
 Realization of growth through intensive allocation of management resources to Core Growth businesses

We will make Core Growth businesses lead growth of the whole company through strategic allocation of management resources, and aim to achieve profitability and capital efficiency high enough to compete on the world stage.

Image of growth by strategic allocation of management resources to Core Growth businesses

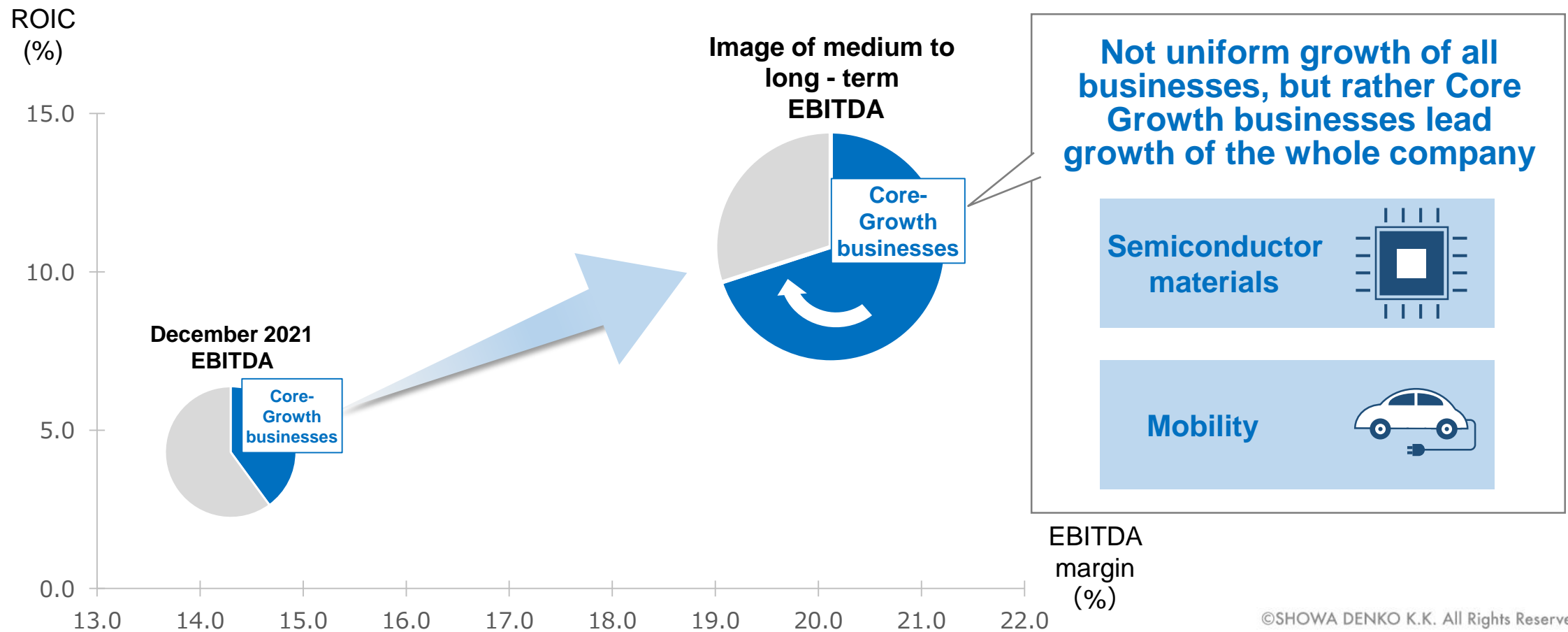

Improvement in portfolio management
 Change to new segments for disclosure in line with
 new business portfolio strategy

We will change segments for disclosure, aiming to clearly show effects of strategic allocation of management resources, and continuous revision and replacement of business portfolio.

New segments	Businesses	EBITDA margin (Target for 2025)
Semiconductor and Electronic Materials	Electronics	30% or more
	Device Solution (HD) / Device Solution (SiC)	
Mobility	Mobility	20% or more
Innovation Enabling Materials	Ceramics / Functional Chemicals (resins, etc.)	15% or more
	Aluminum Specialty Components / Coating Materials	
Chemicals	Petrochemicals / Carbon	15% or more
	Industrial Gases / Basic Chemicals	
Others	Life Science	Achieve critical mass

【Business environment】 Market expansion of semiconductor materials caused by changes in technological trends

While miniaturization and cost reduction in the front-end process are reaching the limit, they are realizing combination of high performance and low cost through packaging technology in the back-end process

【Past】 Performance improvement through miniaturization in the front-end process

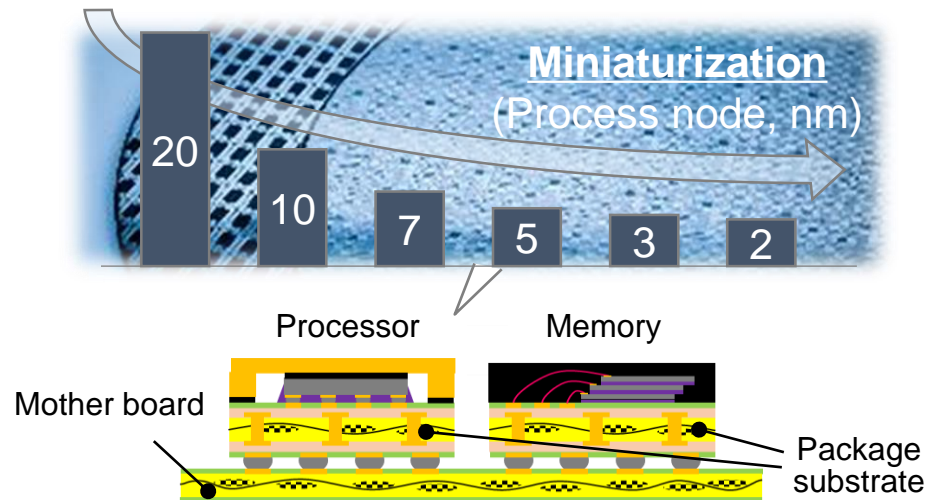

【Hereafter】 High integration with 2.x/3D packaging

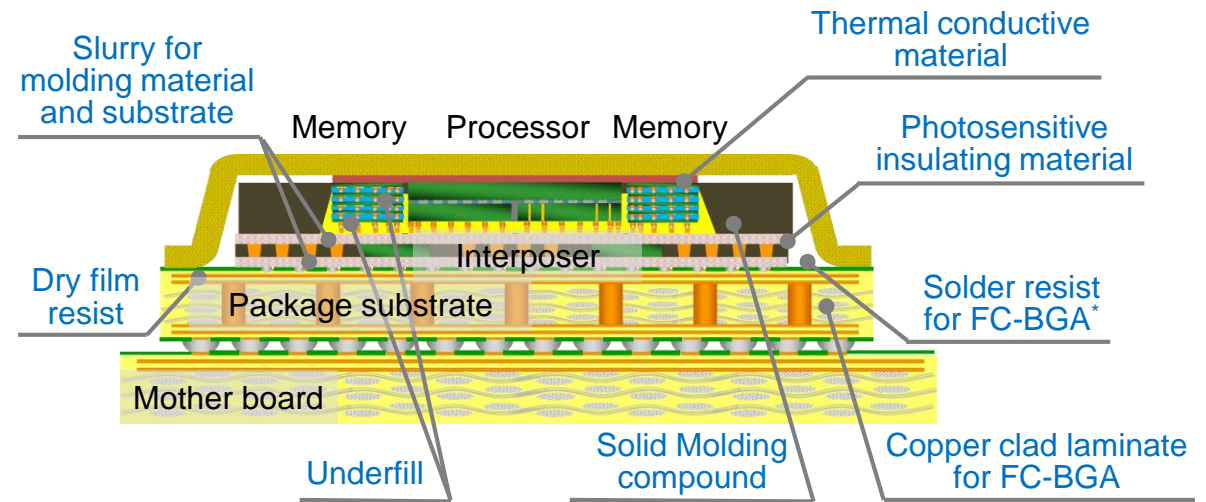

High performance with miniaturization

- ✓ **Development investments in packaging technology are limited** compared to front-end process technology
- ✓ Performance improvement with miniaturization is going to **the physical and economical limits**

Increased importance of packaging-related materials

- ✓ **Highly value-added semiconductor materials** affect packaging technology in back-end process
- ✓ **Increased usage of semiconductor materials** due to increase in number of layers and expansion of packaging size
- ✓ **Adoption of new materials** due to further integration and miniaturization

Note) *FC-BGA : Flip Chip-Ball Grid Array

【Competitive advantage】 High share lineup of semiconductor materials for 2.x/3D packages

Our lineup of semiconductor materials are competitive and conforming to technical trends.

We are improving competitiveness with our semiconductor materials

by utilizing Packaging Solution Center and JOINT2*1, and committing quick management resources.

Semiconductor materials for production process of 2.x/3D packages

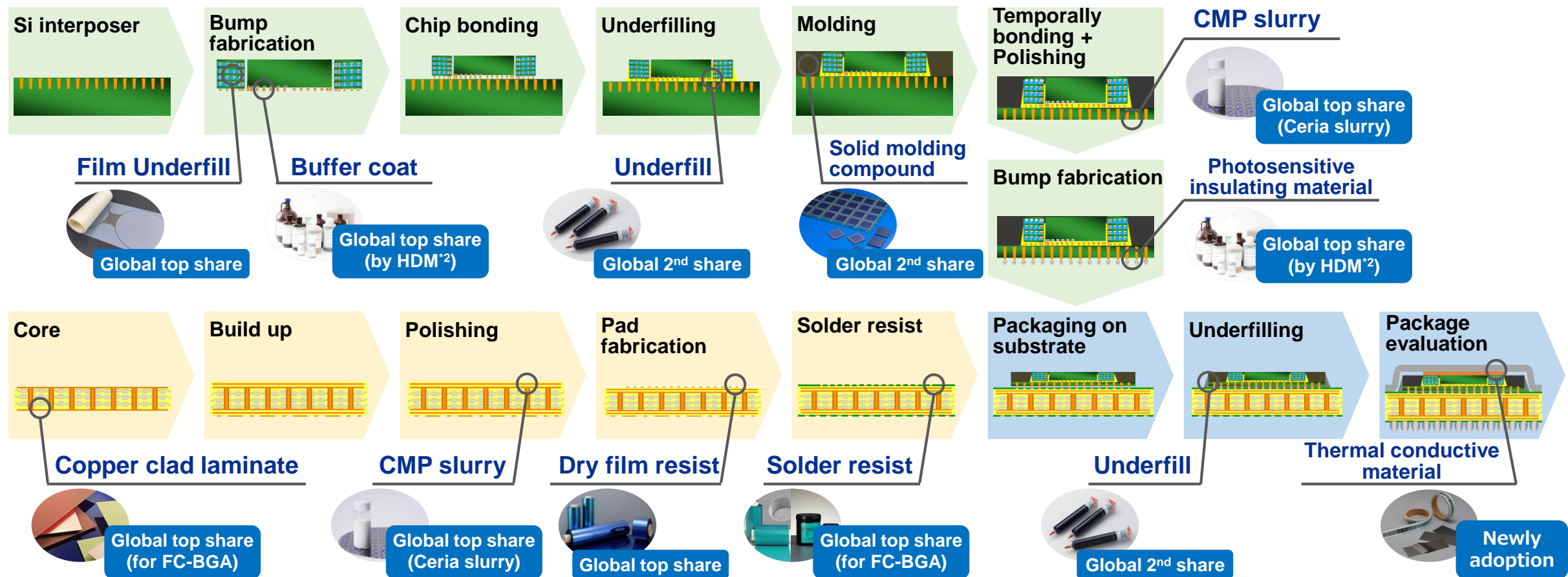

Improvement in portfolio management: Growth strategy of Core Growth business (Semiconductor Materials)

Potential growth of semiconductor and electronic materials



We have rich lineup of functional materials for fields of devices, network, and cloud computing where growth is expected due to the progress of IoT.

Image of connected society due to the progress of IoT

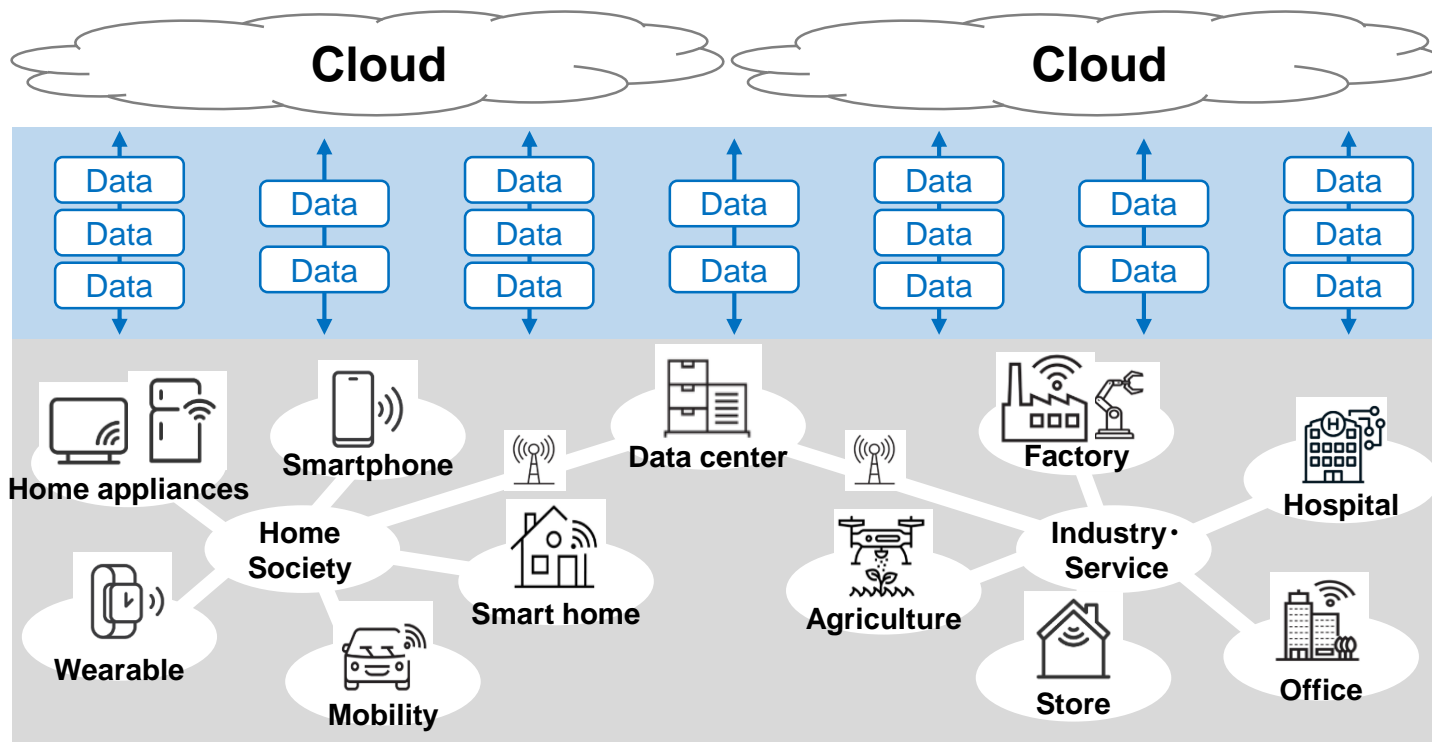

Due to the progress of connected society, device, network, and cloud computing become more important. Thus, the demand for semiconductor materials and electronic materials is expected to potentially grow further.

SDK's lineup of semiconductor and electronic materials

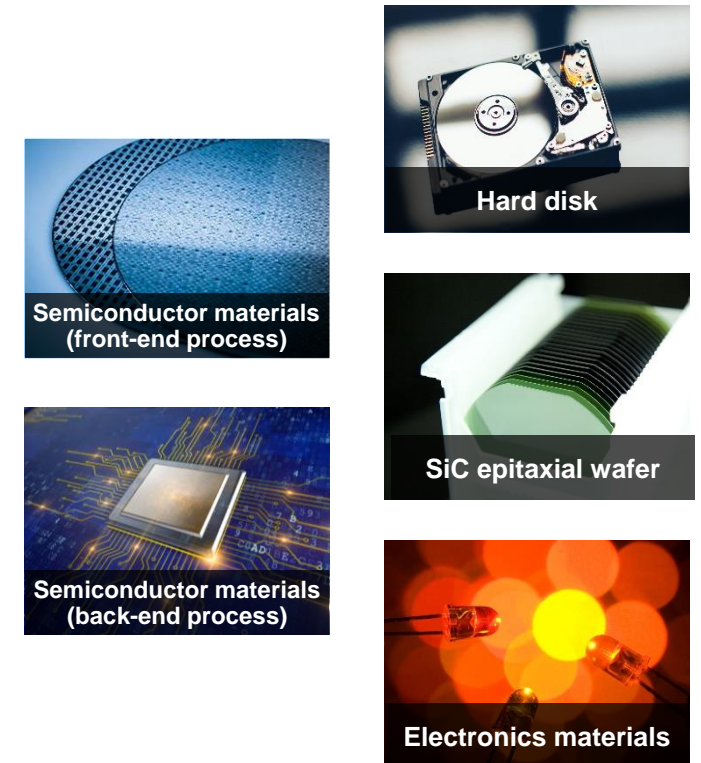

Growth scenario of semiconductor materials and sales forecast of semiconductor and electronic materials

Growth scenario of semiconductor materials (Factorization)

Market growth of final products (semiconductors)

105% ~ 108%



Change in the amount of materials used per unit of final products

99% ~ 123%

Growth driver

- e.g.) **Copper clad laminate: About 116%**
 Increase in size of package of FC-BGA (about 111%) and thickness (about 105%) increase the amount of copper clad laminate used in semiconductor production
- (C₄F₆): About 115%**
 Increase in number of layers of 3D-NAND increases the amount of used gas
- CMP slurry: About 105%**
 Increase in number of layers and changes in structure of 3D-NAND increase the number of layers of copper clad laminate

Expected growth rate

104% ~ 133%

We will realize growth of our businesses higher than market growth by maintaining and improving high competitiveness (world top-class market share and added value)

Medium to long-term sales forecast of semiconductor and electronic materials

(unit: billion yen)

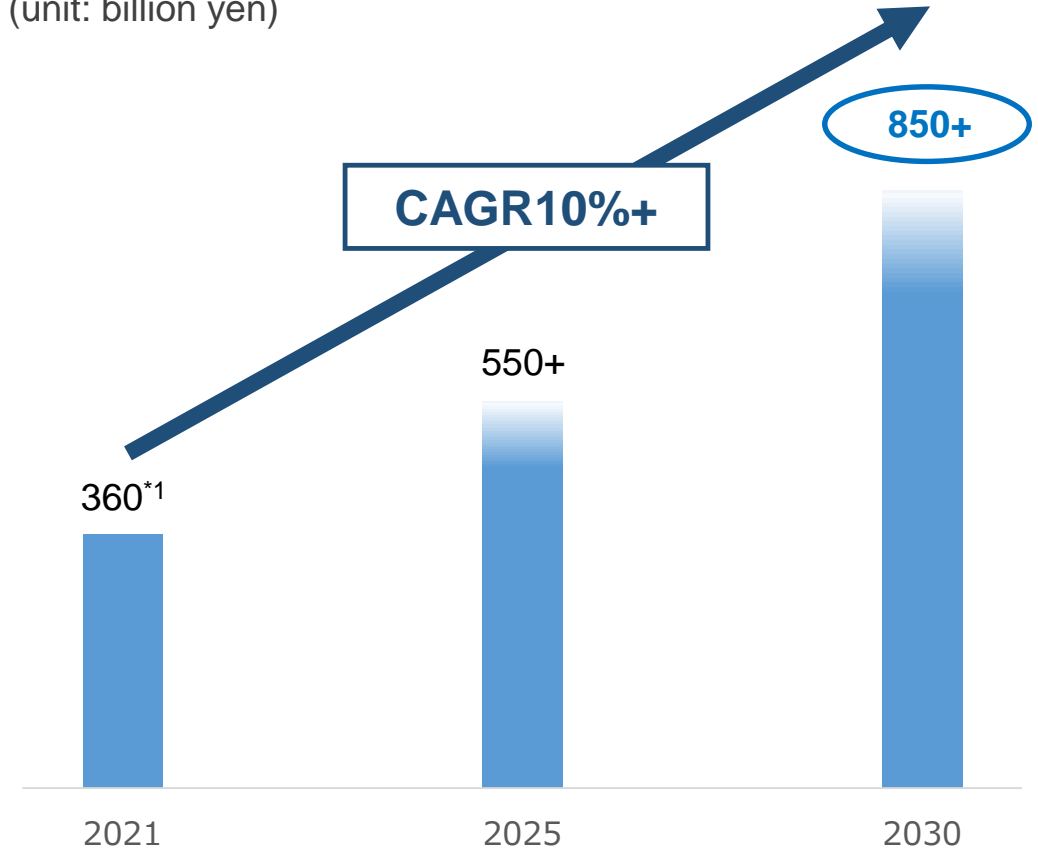

We changed the subject of sales forecast of growth businesses from those in the “Long-term Vision for Newly Integrated Company” to semiconductor and electronic materials

Note) *1: These amounts are based on internal forecast for management, and include the effect of sale of business and etc.

*2: Forecasts above are made by SDK and based on information available as of today. Therefore results in the future may change due to changes in various factors and risks.

Growth strategy for Core Growth business (Mobility)

Growth strategy for Mobility business

Increased technical needs due to progress of CASE, especially the spread of xEVs

Weight reduction

The spread of xEVs requires further weight reduction of parts as countermeasure against weight increase caused by heavier batteries

Electrification

5G and increase in network connection requires high-performance battery

Heat control

Downsizing and weight reduction require high-performance and light-weight heat management device

Business opportunity

SDK Group's products

Rear door module



Nissan "X-TRAIL"

Plastic gears



LIB anode material



Advanced battery materials (VGCF™)

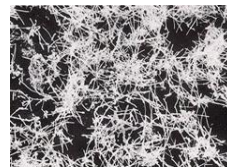

Water jacket



Aluminum radiator

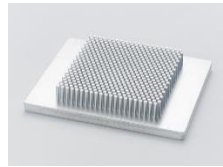
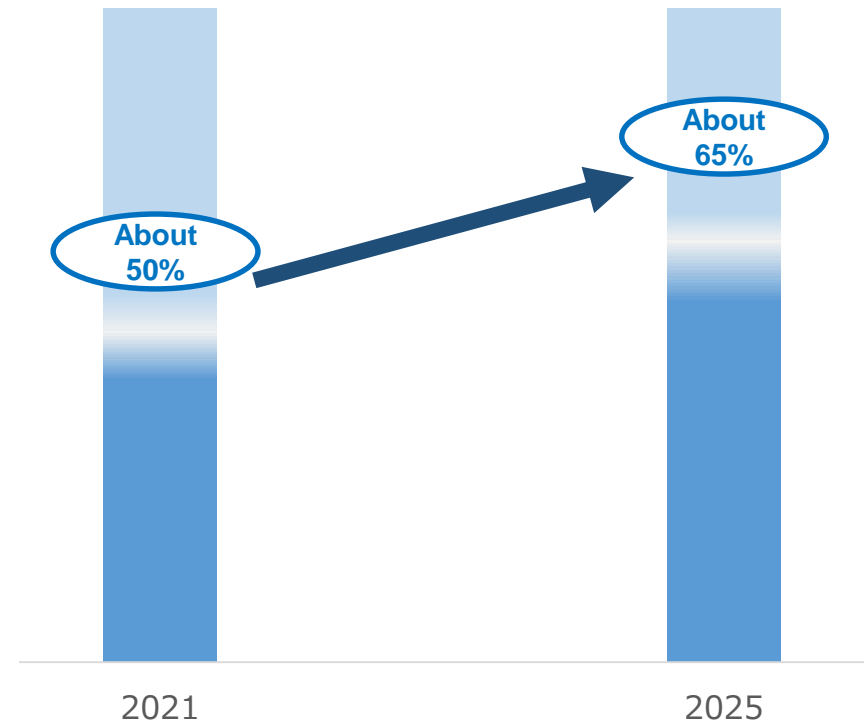

Image of growth of Mobility business (Ratio of CASE-related businesses)

Setting new customer needs caused by progress of CASE as a key growth driver, we will make our mobility business grow by capturing market growth

- : Ratio of products for CASE
- : Ratio of other products



Innovation (Technology x Business model)

Strategy to establish competitive advantage (marketing, research and development)



Through possession of wide-ranging materials and technologies covering midstream to downstream, we will clarify customers' needs at downstream, realize innovations by reconciling technologies, and provide customers with value.

Source of competitiveness

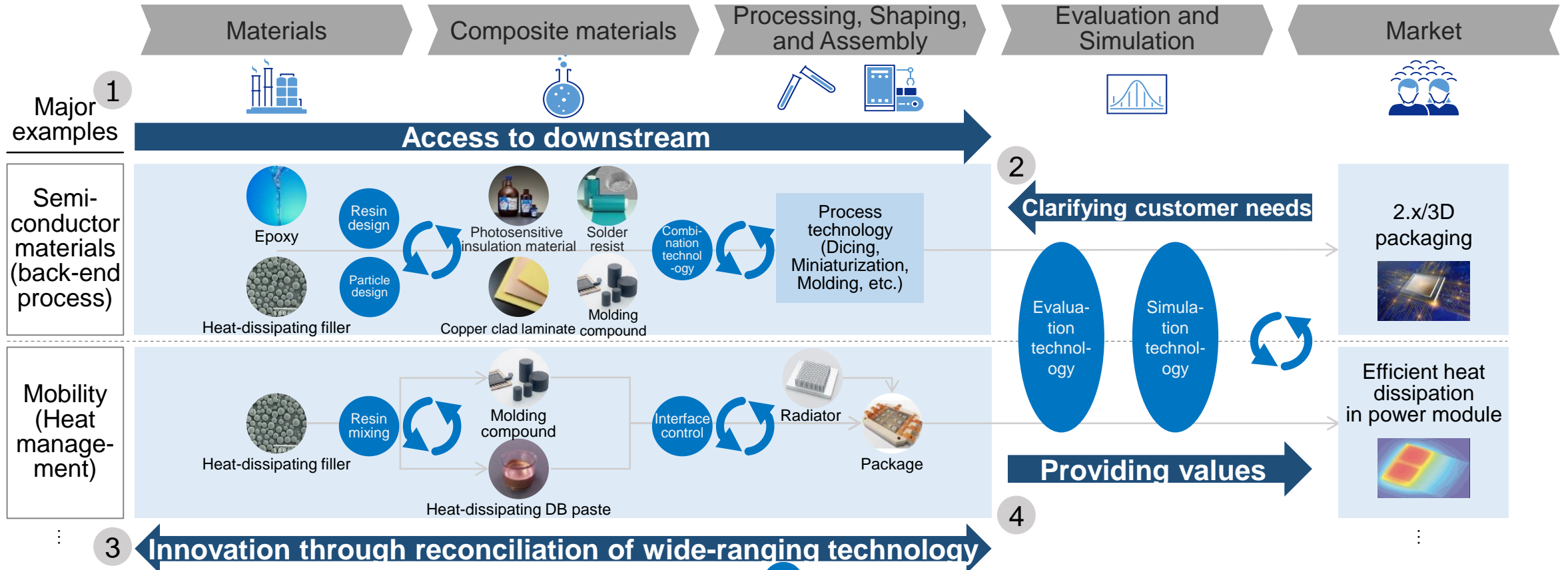

We assessed all of our elemental technologies, and specified "sources of competitiveness" as keys for reconciliation of technologies. We will make the sources match with our business and R&D strategies.

How our semiconductor materials will compete in the market by utilizing JOINT2

We will promote JOINT2*1, a project to promote open innovation in semiconductor packaging materials and production process, together with other business partners, thereby contributing to solve technical issues concerning semiconductor package in next generation.

JOINT 2, a consortium for developing technology for mounting semiconductor package in next generation

Outline

- We will develop evaluation technology, substrates, materials, and devices by utilizing evaluation platform.
(Main base: Packaging Solution Center (Kawasaki City, Kanagawa Prefecture))
- We can conduct trial manufacture and evaluation of 2.x/3D semiconductor package by utilizing fine-wiring with stepper and laser dicing.

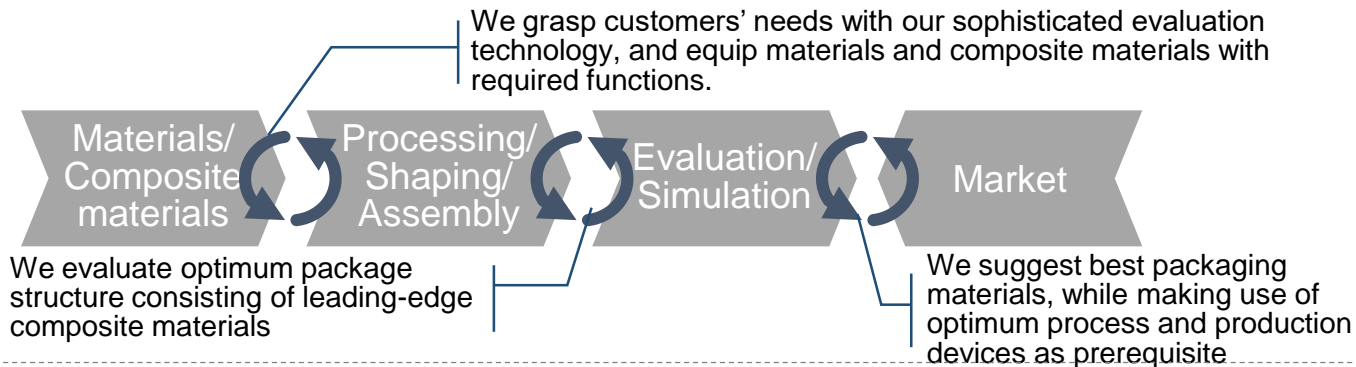

Aims

- We aim to solve technical issues in production of next-generation semiconductor package through **reconciliation between materials and devices of member companies**
- We **make it possible for us to suggest one-stop solutions optimum for customers and secure predominant position** by combining not only our own materials but also other member companies' materials and technologies.

Packaging Solution Center

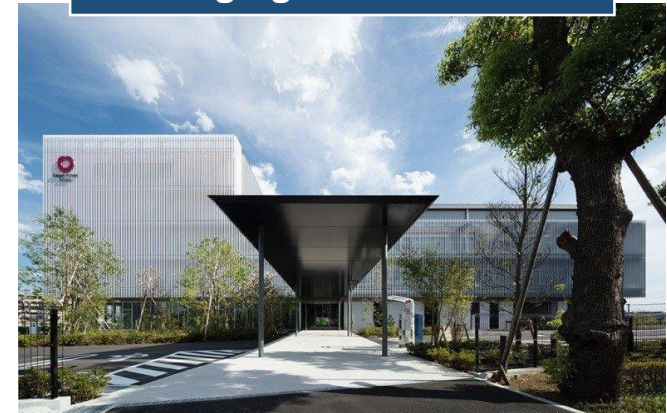

- 12 member companies of JOINT2
- Ajinomoto Fine-Techno Co., Inc.
 - C. Uyemura & Co., Ltd.
 - Ebara Corporation
 - Shinko Electric Industries Co., Ltd.
 - Dai Nippon Printing Co., Ltd.
 - DISCO Corporation
 - TOKYO OHKA KOGYO CO., LTD.
 - NAMICS Corporation
 - Panasonic Smart Factory Solutions Co., Ltd.
 - MEC COMPANY LTD.,
 - Yamaha Robotics Holdings Co., Ltd.
 - Showa Denko Materials. Co., Ltd.

Note) *JOINT : Jisso Open Innovation Network of Tops

Our digital strategy to support innovation

We will introduce advanced digital technologies to support our competitive advantages and accelerate innovation

Image of digital strategy

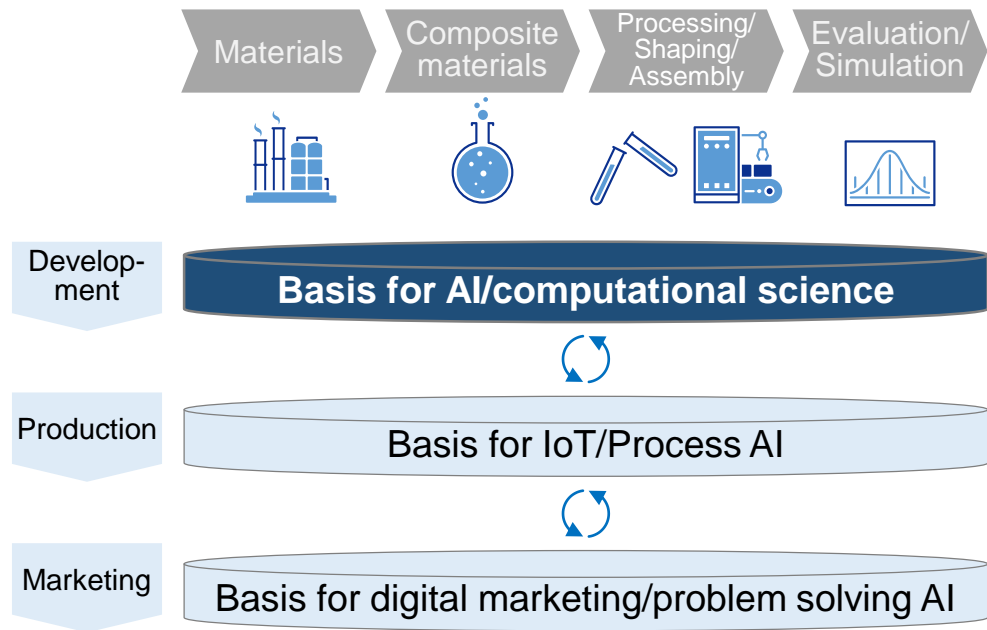

Example of utilizing leading-edge AI/computational science

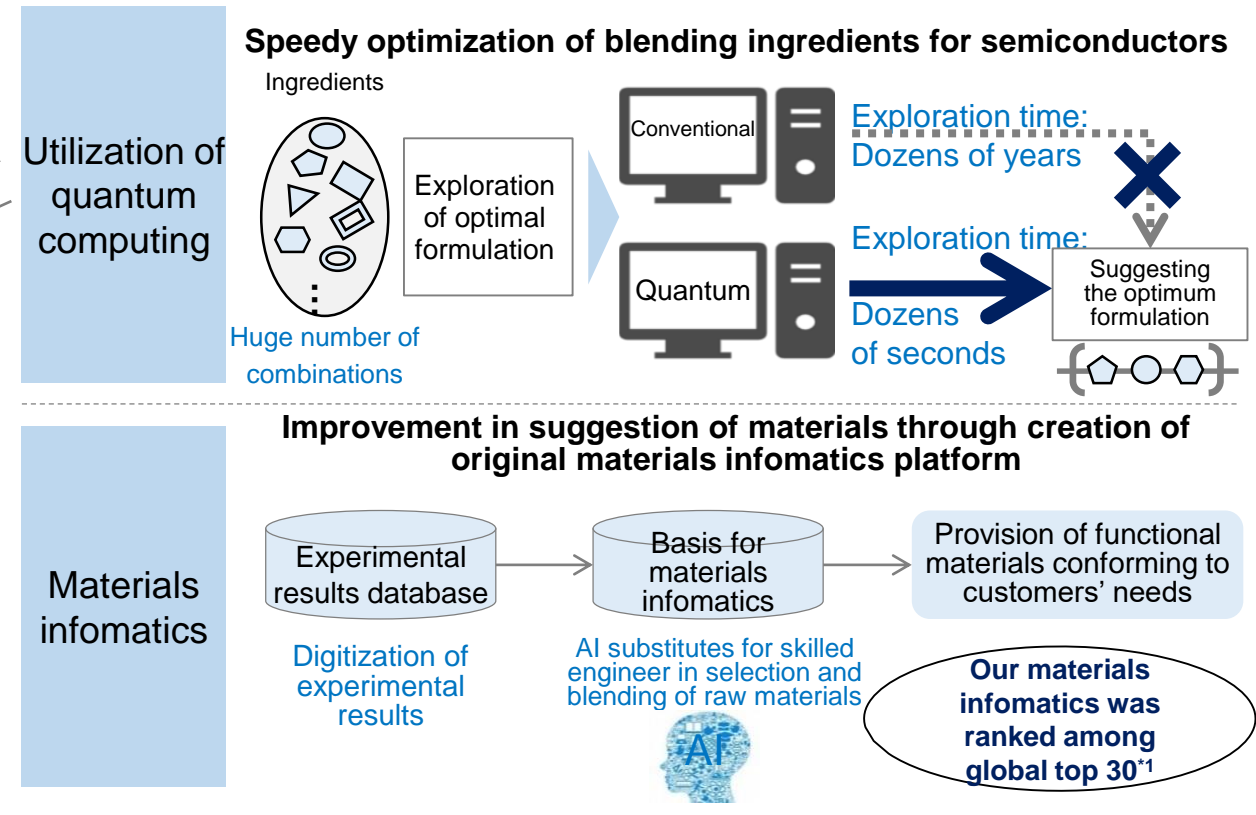

We will utilize digital technology on each functional layer and realize rapid provision of highly value-added solutions

Note) *1: Selected in Lux Research's "Key Players in Materials Informatics 2020"

Our challenge to achieve carbon neutrality

30% reduction from the level of 2013 will surely be achieved with improvement of existing technologies. Realization of carbon neutrality requires development of new technology system through innovation.

Road to carbon neutrality

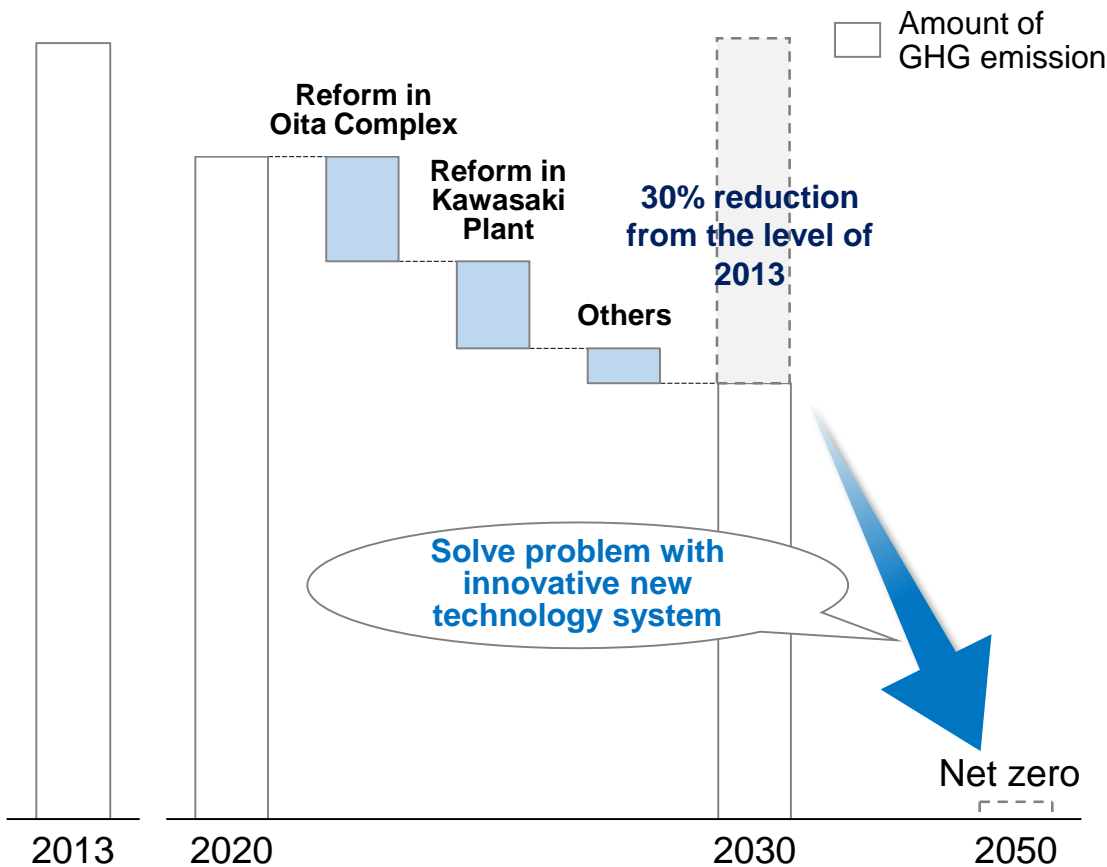

Roadmap for Petrochemicals and Chemicals businesses

Formulate reduction measures for Oita and Kawasaki, which are the company's major sources of emission

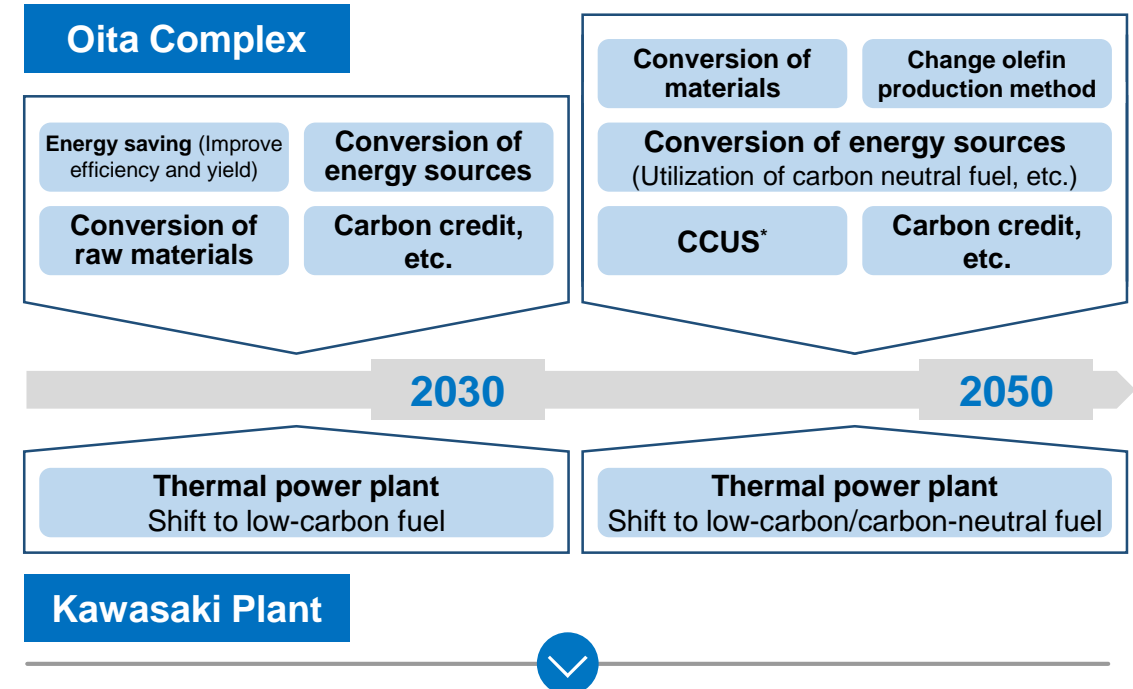

We will promote not only independent measures, but also search for solution through co-creation with stakeholders

Note) *CCUS : Carbon dioxide Capture, Utilization and Storage

Foster talent and culture that can solve social issues

We will promote human resource strategy based on Purpose and Values in order to make this Company be an entity which employees are eagerly wanted by other companies.

Purpose-driven

We will cultivate corporate culture in which autonomous and co-creative persons can grow, lively act and realize Purpose and Values

- ✓ Plant Purpose into oneselves' meaning of work
- ✓ Global Award that praises realization of Values and challenges
- ✓ Secure psychological safety, and respect individuals

Talent management

Management team will train leaders for the future from a viewpoint of company-wide optimum

- ✓ Visualization of pool of talented employees and assignments that develops potentiality
- ✓ Strategic personnel rotation including exceptional promotion and job posting
- ✓ Diversified career paths that make the best use of exceptionally talented employees

“Values” to be shared

Passionate & Results-Driven

Open Minds & Open Connections

Agile & Flexible

Solid Vision & Solid Integrity

New management system and management team

The Showa Denko Group has common CXOs (Chief Officers), aiming to make the most of management team's capability. The Group introduces executive remuneration system that meets global standard, and the management team commits to achieve results required by stakeholders.

Hidehito Takahashi

Chief Executive Officer
(CEO)

Hideki Somemiya

Chief Financial Officer
(CFO)

Tomomitsu Maoka

Chief Strategy Officer
(CSO)

Keiichi Kamiguchi

Chief Risk
Management Officer
(CRO)

Nori Imai

Chief Human Resource
Officer (CHRO)

Hiroshi Sakai

Chief Technology
Officer (CTO)

Masami Tobito

Chief Operations,
Manufacturing and
Engineering Officer
(CMEO)
Chief Quality Officer
(CQO)

Hideki Shibata

Chief Digital Officer
(CDO)

Shigeru Fujita

Chief Marketing Officer
(CMO)

Hiroyuki Yamashita

General Manager,
Preparation Office for
Electronics Business
Headquarters

Yoshito Ishii

General Manager,
Preparation Office for
Mobility Business
Headquarters

Mitsuo Katayose

General Manager,
Preparation Office for
Advanced Functional
Materials Business
Headquarters



Members who have global experience have joined the management team of the Showa Denko Group, and the new management team will lead the reformation for The World's Leading Functional Chemical Manufacturer

Long-term numerical targets

To consider discipline more seriously, we have newly introduced ROIC as a new numerical target. By achieving below targets, we aim to be in the top 25% of TSR in chemical industry in medium to long-term.

		2021 (Actual results)	2025	2030
Net sales*	(¥ trillion)	1.4	1.6	1.8~1.9
EBITDA margin	(%)	14.3%	20%	
ROIC	(%)	4.3%	10% in medium-to long-term	
Net D/E ratio	(times)	1.15	Aim to achieve 1.0	

Note) *This number does not include net sales expected to be recorded by companies as targets of M&A in the future.

Things we should change in order to “Change society through the power of chemistry”

	So far	From now on
Management Policy	<ul style="list-style-type: none"> • Optimum for each division • Technology and individual customer-oriented • Stressing sales and operating income 	<ul style="list-style-type: none"> • Optimum for the entire company/synergy among departments • Society- and market-oriented • Stressing corporate value and ROIC
Organizational Culture	<ul style="list-style-type: none"> • Sectionalism and top-down system • Decision based on rules and regulations • Averting risks 	<ul style="list-style-type: none"> • Lateral communication accelerating co-creation • Decision based on purpose/values • Praising challenges and failures
Personnel System	<ul style="list-style-type: none"> • Seniority system, rigidly uniform compensation • Single career path • Limited department transfer 	<ul style="list-style-type: none"> • Merit system, appropriately varied remuneration • Career options that utilize the strength of each individual • Personnel rotation, job posting

Newly integrated company's direction

A wide-angle photograph of a sunrise over a mountain range. The sun is low on the horizon, creating a bright glow and lens flare effects. The sky is a mix of light blue and white clouds. The mountains are silhouetted against the bright light.

**We will transform the newly-integrated company into
a company that can compete on the world stage**

Note

Performance forecast and other statements pertaining to the future as contained in this presentation are based on the information available as of today and assumptions as of today regarding risk factors that could affect our future performance. Actual results may differ materially from the forecast due to a variety of risk factors, including, but not limited to, the influence of the coronavirus disease 2019 (COVID-19) on the world economy, the economic conditions, costs of naphtha and other raw materials, demand for our products such as graphite electrodes and other commodities, market conditions, and foreign exchange rates. We undertake no obligation to update the forward-looking statements unless required by law.