

ESG Briefing 2023

Murata Manufacturing Co., Ltd.

2023.3.2

Key Messages

- Overview of Murata's ESG-related initiatives
- We will practice management that creates a continuous cycle of social and economic value in order to realize sustainability for society and for our company
- To achieve this, we will co-create value through dialogue with our stakeholders

01

Vision2030 and key issues (Materiality)

Vision 2030

Vision 2030 sets out in detail what we must do in the future to realize the mission set out in the Murata Philosophy. The key concepts in implementing this vision are a “Continuous cycle of social and economic value” and “Co-creating value with stakeholders.”

Murata Philosophy

We contribute to the
 advancement of society
 by
 enhancing technologies and skills
 applying scientific approach
 creating innovative products and solutions
 being trustworthy
 and, together with all our stakeholders,
 thankful for the increase in prosperity.

Innovator in Electronics

Murata will innovate to create a continuous cycle of social and economic value and contribute to the enrichment of society.

Murata in everyday life

Murata's electronic components are used as an essential part of the social infrastructure for enriching people's basic needs. Murata will continue to respond to society's needs with constant innovation and promote the evolution of components. Murata's components are broadly and deeply rooted in society and support people's everyday lives.

Practicing sustainable operations

Murata will innovate to reduce the impact of our business operations on society and the environment. We are committed to realizing our business processes that are in harmony with society.

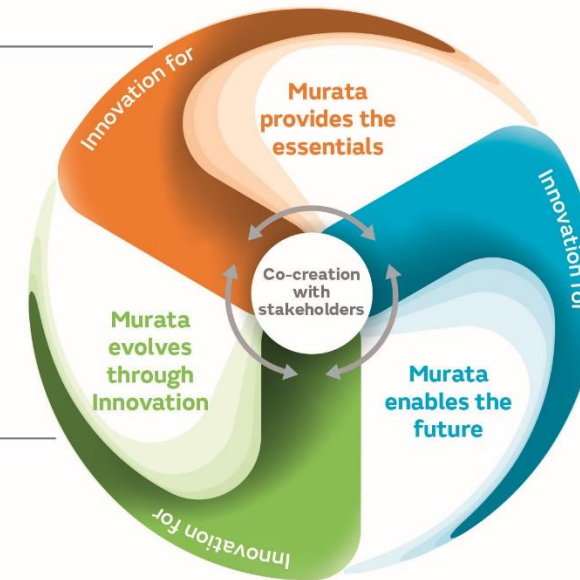

Solving social issues

Electronics are also widely used as tools for solving social issues. Murata will not just provide components but will utilize electronics as a breakthrough to pursue sustainability of the Earth and society. Murata's innovations will accelerate the realization of an unrestricted, more convenient future.

Global No. 1 Component & Module Supplier

Murata will be the best choice for customers and society

Process of Value Creation



Innovator in Electronics

Reinforcement of corporate governance system

Growth strategies

Deepen core businesses and promote evolution of business models

- Three-layer portfolio
- Four business opportunities

Execute four management transformations

- Management that creates a continuous cycle of social and economic value
- Autonomous and decentralized organizational management
- Change-responsive management based on hypothetical thinking
- Digital transformation (DX)

Key issues (materialities) originating with social issues

Contribute to solving social issues through our business



Initiatives on social issues through business activities overall

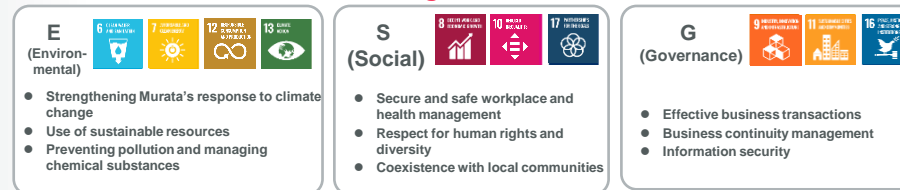

What Murata wants to be

Murata will innovate to create a continuous cycle of social and economic value and contribute to the enrichment of society

Murata provides the essentials
Murata in everyday life

Murata enables the future
Solving social issues

Murata evolves through innovation
Practicing sustainable operations

Global No. 1 Component & Module Supplier

Value creation with stakeholders

Economic value

Social value

Strengthen management foundations

Recognizing the environment (opportunities and risks)

Murata's core competencies

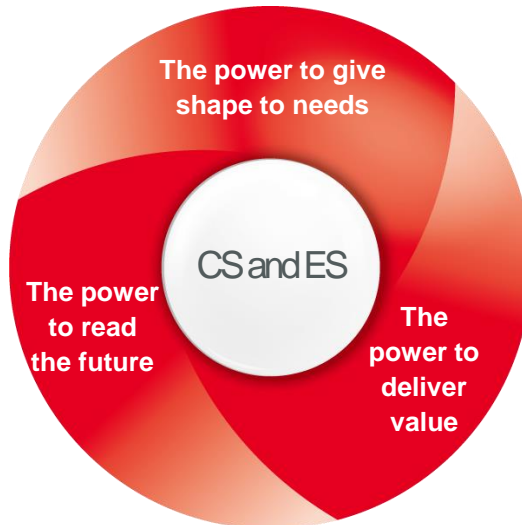

Management capital that we have cultivated by implementing the Murata Philosophy

- Human capital
- Organizational capital
- Monozukuri capital
- Intellectual and technological capital
- Customer and business partnership capital
- Financial capital

Murata Philosophy (management philosophy)

Economic value (FY2024 target)

Net sales
(JPY)

2,000 billion

Operating
income ratio

20% or higher

ROIC (before tax)

20% or higher

* ROIC (pre-tax basis) = Operating income / Invested capital (Property, plant and equipment + Inventories + Trade accounts receivable - Trade accounts payable)

Social value ① “Environment”

Amount of GHG
emissions

vs. FY2019, Scope: Scope 1 + Scope 2

FY2024: Reduce by 20%
FY2030: Reduce by 46%

Renewable energy
implementation rate

FY2024: 25%
FY2030: 50%
FY2050: 100%

Rate of use of sustainable
resources*¹

FY2024: 1%*³
FY2030: 25%
FY2050: 100%

Resource recycling rate*²

FY2024: 5%*³
FY2030: 50%
FY2050: 100%

Social value ② “Diversity”

Percentage of overseas indirect employees with
experience working at other sites*⁴

FY2024: 7%
FY2030: 10%

Social value ③ “ES*⁵”

Positive employee
engagement response rate

FY2024: 70% or higher
FY2030: 76% or higher

*1: Rate of use of sustainable resources: Ratio of resources with lower risk of depletion that can be used sustainably by building a recycling scheme, etc. (Potentially depletable resources: Ag, Ni, etc.)

*2: Resource recycling rate: Rate of Murata’s output (emissions) recycled as resources

*3: FY2024 targets indicate the range of improvement from current state

*4: Applies to overseas local staff, excluding those transferred from Japan to overseas

*5: ES (Employee Satisfaction): every employee achieves satisfaction and continuing growth through the performance of their work duties.

Continuous Cycle of Social and Economic Value

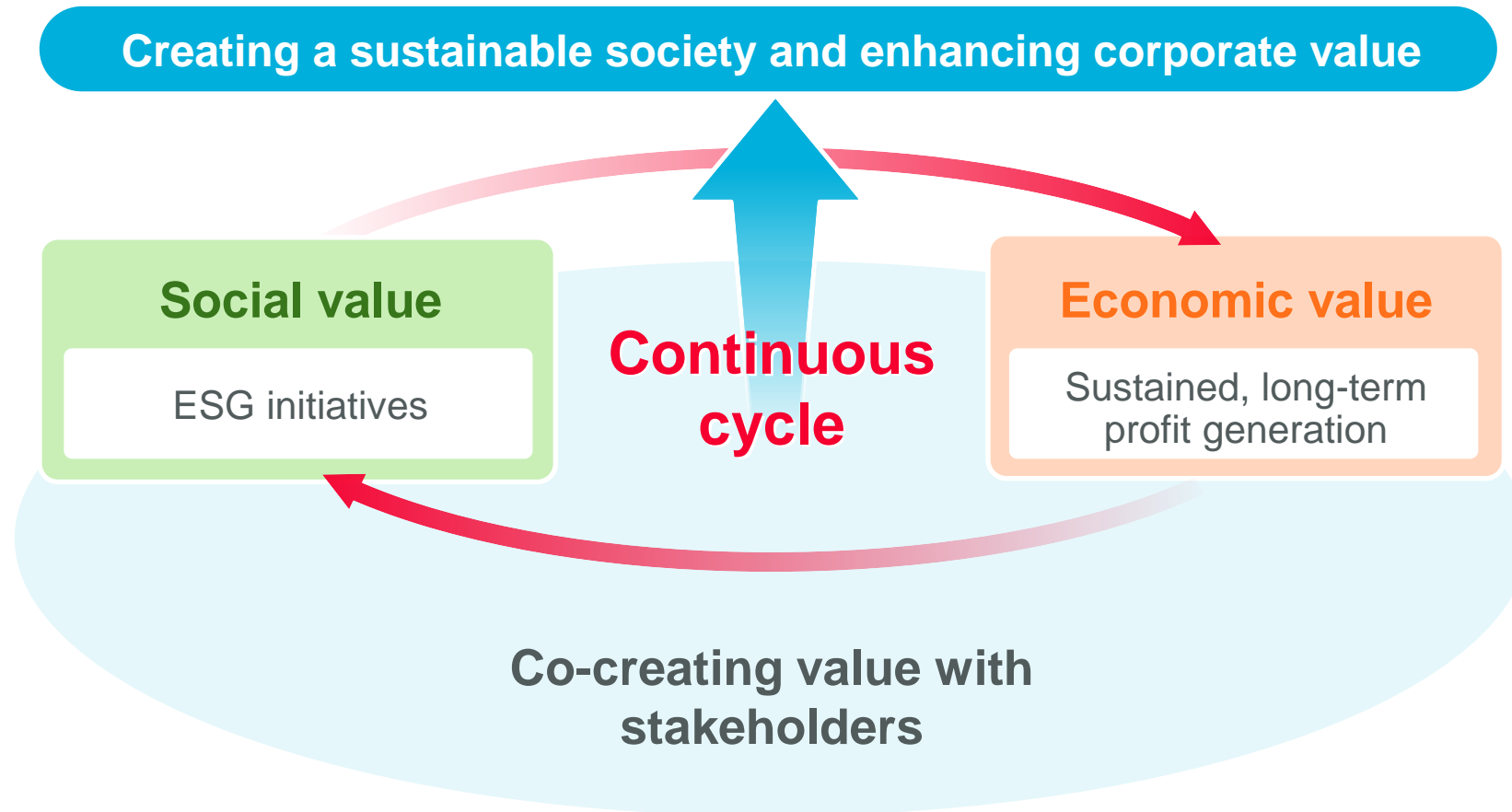

- Produce a continuous cycle of social and economic value by co-creating value with stakeholders
- Actively work to resolve social issues, in this way improving our business competitiveness

Key Issues (Materiality) Originating with Social Issues

Contribute to solving social issues through our business

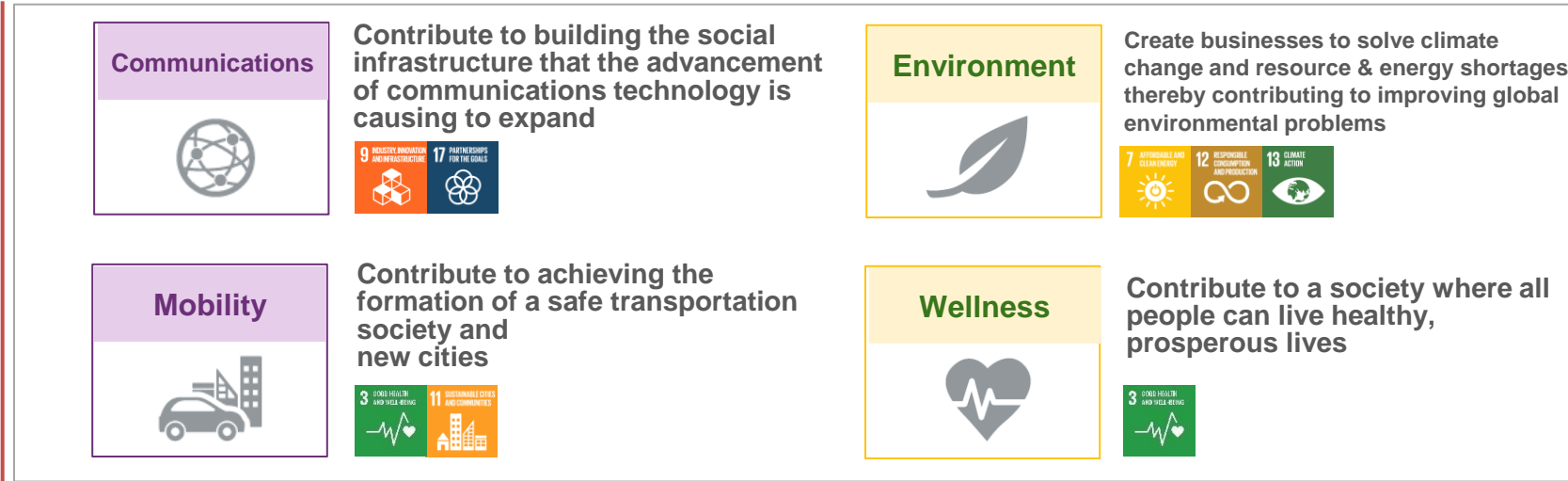

X

Initiatives to solve social issues through business activities overall















02

Contribute to solving social issues
through our business

Contribute to Solving Social Issues through Our Business

Set a course of action for solving social issues in four business opportunities as materiality

Materiality	Recognized business opportunities	Murata's contribution
 <p>Communications</p>  	<ul style="list-style-type: none"> Increasing demand for components as communication systems evolve Diversifying built-in communication applications Emerging data-driven solutions and services Building the network infrastructure to support the above, and advancing the development of smart cities Merging real and virtual, including the expansion of XR technology 	<ul style="list-style-type: none"> Providing high-quality components that contribute to the stability of the communication systems and network infrastructure that have become indispensable social infrastructure for enriching people's lives Contributing to the evolution of communication systems and the development of applications through knowledge cultivated in the field of continuous technological innovation and communication
 <p>Mobility</p>  	<ul style="list-style-type: none"> Increasing demand for components as automobiles evolve through safety enhancement including the spread of advanced driver assistance systems (ADAS) and autonomous driving, as well as the advancements of electrification Integrating various transportation modes and services emerging under the concept of Mobility as a Service (MaaS), which positions transportation itself as a service 	<ul style="list-style-type: none"> Contributing to achieve the formation of a safe and secure transportation society, and a society that integrates various means of transportation and services through miniaturization, increased functionality and enhanced reliability of components
 <p>Environment</p>   	<ul style="list-style-type: none"> Accelerating initiatives to transition to a decarbonized society Advancing the circular economy, which places value on product repair, reuse, and resource recycling Advancing the development of environmental technology (clean tech) in all industry segments 	<ul style="list-style-type: none"> Contributing to a decarbonized society through the battery and power supply business, with our competitive advantage of safety, security, high efficiency, and long life Enabling monitoring of various environmental aspects through communication and functional components, and accelerate the realization of a decarbonized society and circular economy Deploying production expertise related to energy saving and renewable energy acquired in our process improvement activities widely outside the Company
 <p>Wellness</p> 	<ul style="list-style-type: none"> Transforming the medical and healthcare domain using digital technology Expanding initiatives in preventive medicine and health promotion in line with the acceleration of the population aging Changing health concepts, including balanced mental and social health in addition to physical health, and the pursuit of people's own happiness 	<ul style="list-style-type: none"> Contributing to the acceleration of digitalization in the medical and healthcare domains by providing compact, high-quality electronic components Provide solutions for extending healthy life expectancy and enabling vibrant lifestyles free from anxiety by combining Murata's technologies and ideas

1 Our high market share products are installed in many communication devices, supporting the electronics society [industry]

Supporting the electronics industry by continuing to provide a steady supply of products

MLCCs

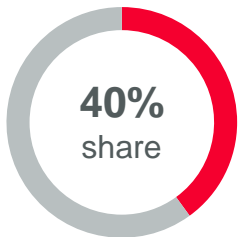

Radio frequency inductors

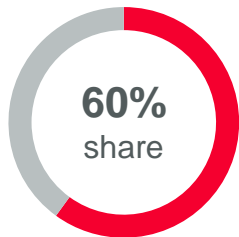

SAW filters

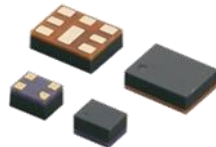
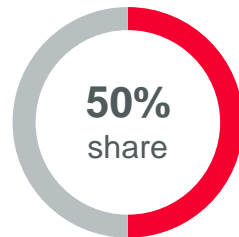

Social value that we provide

Helping maintain the electronics industry with a stable supply of products

2 Cutting-edge products that support innovation

Contributing to the evolution of applications and electronic devices by continuing to provide cutting-edge electronic components

Ultracompact products



WiFi7-compatible module

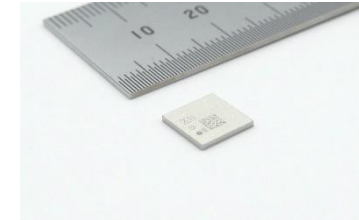

Edge AI modules



Social value that we provide

Contributing to the evolution of communication systems and the development of applications

1 MLCCs that contribute to the electrification of vehicles and the evolution of autonomous driving

- We have a 50% share of MLCCs for automobiles, and the evolution of electrification and autonomous driving technology will have a major impact on business performance and society.
- Our strengths are our technological capabilities that allow us to create highly reliable, high-performance products, and supply capacity that enables us to mass-produce products with uniform quality.

Number of MLCCs used (pcs., according to Murata research)

Conventional vehicles Autonomous driving Level 0	HEVs Autonomous driving Level 2	EVs Autonomous driving Level 3
3,000	6,000 or more	10,000 or more

Social value that we provide

- Contributing to a decarbonized society by deploying EVs
- Contributing to safety, such as driver assistance by stabilizing the electrical systems of automobiles with highly reliable components

2 RFID contributes to resolving issues in the logistics industry

We have worked with Michelin to jointly develop RFID tags that can be embedded in automotive tires. This contributes to DX in the logistics industry, such as tire life management, supply chain management, and significant reductions in inspection times.



Social value that we provide

- Preventing traffic accidents by predicting and managing when tire inspections are required
- Responding to the challenge of the labor shortage in the transportation industry

Reducing environmental impact with light, thin, short, and small product characteristics

Contributing to resolving social issues by promoting light, thin, short, and small product characteristics

Social value that we provide

- Reducing materials used in manufacturing and packaging
- Reducing the energy used in manufacturing and transportation
- Helping to improve convenience for varied lifestyles with compact electronic devices

Economic value that we provide

- Strengthening the competitive advantage of products with our environmental response
- Reducing the costs of materials and energy
- Improving production efficiency and a better product mix

Reducing power used in manufacturing (MLCCs example)

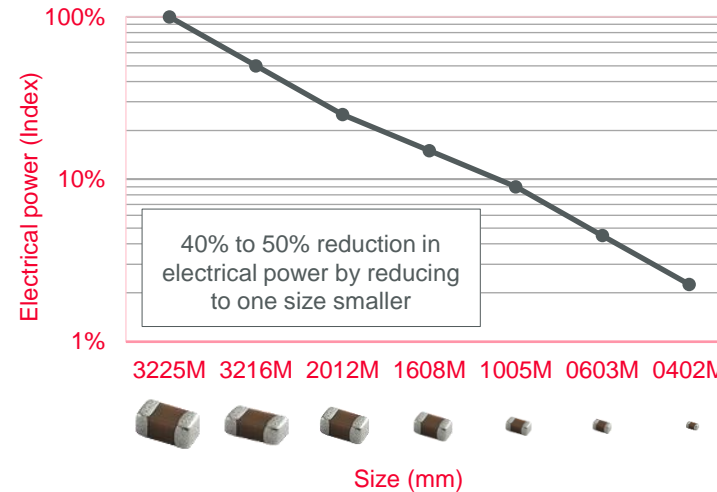

Reducing materials used in manufacturing (MLCCs example)

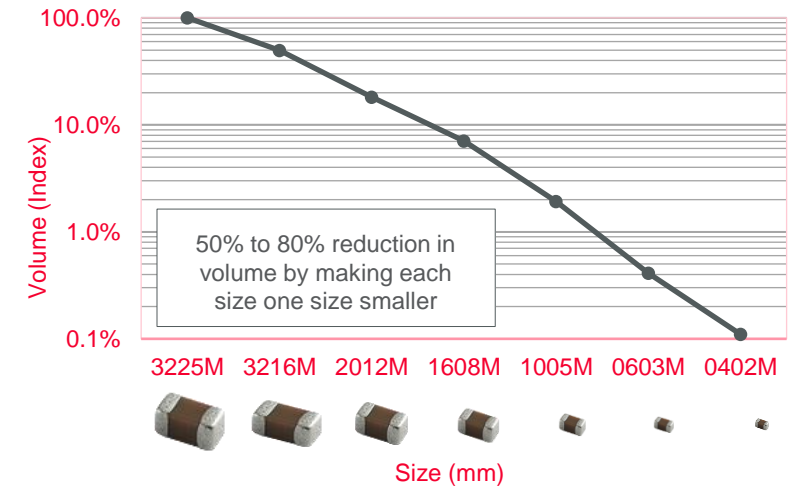

Using higher performance to reduce number of components

Space-saving antenna array integrated module for mmWave 5G

This product makes it possible to emit radio waves in two directions with a single RFIC* by forming an L-shaped multilayer resin substrates and placing an antennae on each of two boards facing different directions. This contributes to reducing the number of components in electronic devices and manufacturing costs.

* An IC that performs amplification and phase adjustment for radio frequency transmission/reception signals.

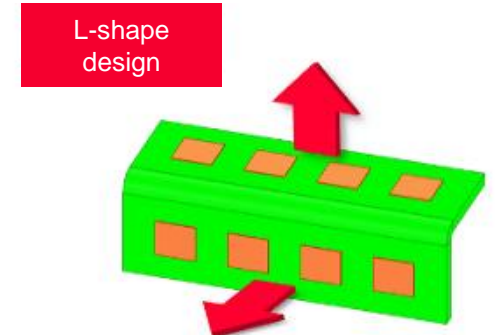
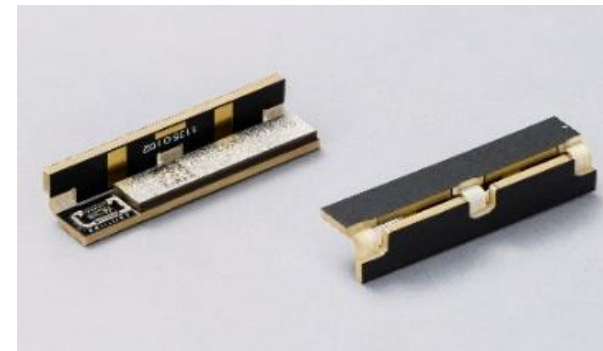

Improving energy efficiency

Power supply modules

- In data centers, addressing the rapid increase in energy consumption has become a common issue.
- Murata's power supply modules contribute to energy conservation through high efficiency, low heat generation, conserved space, and low noise at the component level.
- For high-power products, approximately 80% of our power supply products that have received 80 PLUS* certification are rated TITANIUM, the highest rating of 80 PLUS certification. Further, we have reduced system power consumption by 10% through concentrated power supplies (internal experiment results).

* 80 PLUS is a power saving program for electrical equipment promoted by the 80 PLUS Program.



Reduction of factory fuel consumption and fuel-derived CO₂ emissions

Highly heat-resistant catalyst for exhaust gas treatment equipment (under development)

- Exhaust gas generated in the electronic component manufacturing process is decomposed and eliminated by burning it with natural gas using a large regenerative thermal oxidizer (RTO).
- To reduce the amount of natural gas consumed by the RTO, we installed precious metal-free high heat resistance catalysts developed by Murata in some of our factories from October 2021. We plan to install them in more factories in the future.

High heat-resistant catalyst installed in RTO

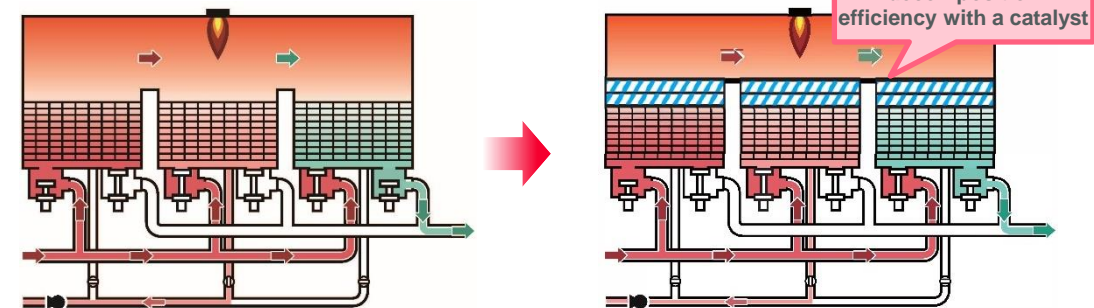

Reducing annual natural gas consumption by about 30%!

1 A worker safety monitoring system that ensures the safety of workers by visualizing risks

The worker safety monitoring system uses helmet-mounted sensors to monitor workers' biometrics and the surrounding environment. This helps meet field safety management requirements, such as keeping workers safe and preventing accidents by detecting close calls.



Examples

- Heat exhaustion countermeasure when performing work on construction sites in summer
- Safety management for infrastructure maintenance workers
- Monitoring and safety management for facility management personnel working alone in factories and energy plants

Social value that we provide

- Identifying safety management risks and saving on manpower requirements at worksites with personnel shortages
- Health and safety management for workers operating in hot environments

2 Fatigue stress monitor for visualizing fatigue levels

Based on vital statistics, such as heart rate and pulse, this monitor accurately measures heart rate variabilities, visualizing the degree of fatigue and stress (previously not easily evaluated) based on the balance of autonomic nerves and other data.



* This product is not a medical device

Examples

- Employee health monitoring
- Visualization of fatigue and stress levels of drivers, etc.
- Product and service evaluation by pharmaceutical, health food, and relaxation-related companies

Social value that we provide

- Preventing health problems and monitoring work safety and hygiene risks
- Fostering a mindset of actively maintaining and improving one's own health

03

Environment

Framework for Promoting a Response to Climate Change

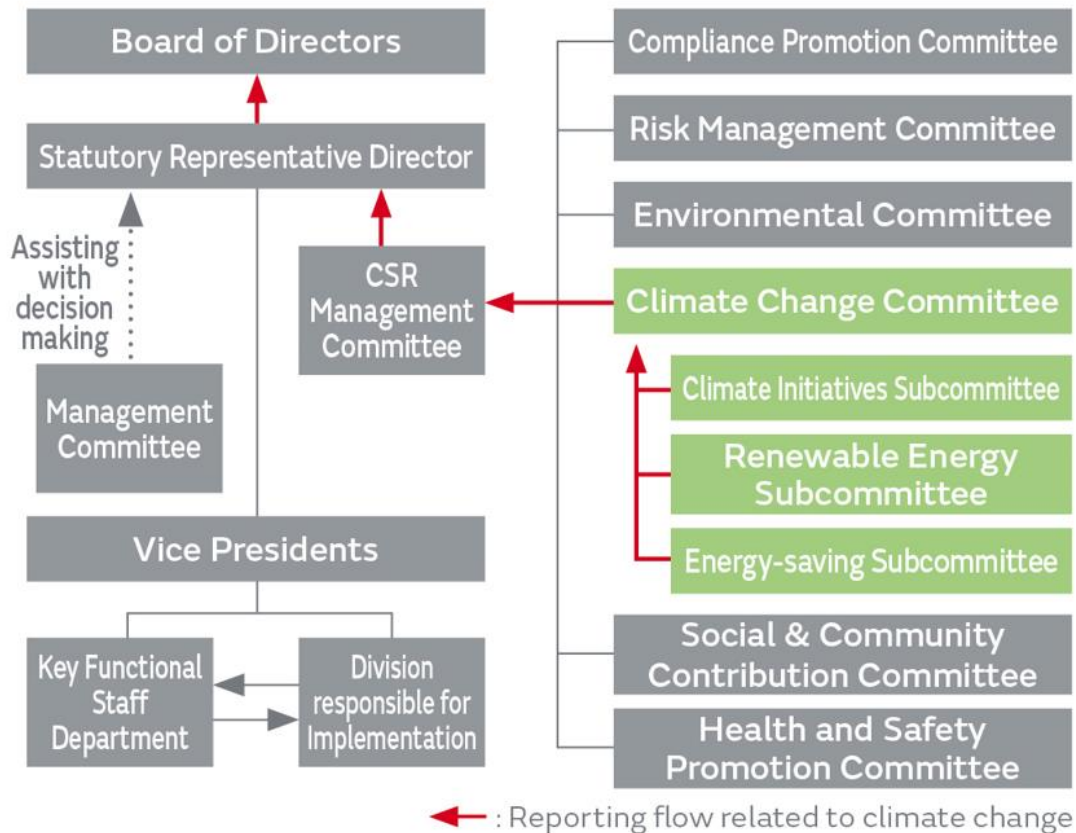

* As of March 2023

Climate Change Committee		
Roles	Governing Murata's overall strategies in response to climate change and monitoring the achievement of climate-related targets across the Murata Group. Committee Chairperson: Executive Vice President	Members
		People responsible for Business Department, <i>Monozukuri</i> Management Department, Research and Development Department, Sales Department, Environment Department, presidents and heads of Management Departments of domestic and overseas subsidiaries, etc.
Climate Initiatives Subcommittee		
Roles	Deliberating on the implementation of climate-related strategies and offering a platform for collaboration and sharing best practices across the Company as well as striving to expand the disclosure of information in accordance with the TCFD.	Members
		Members of Environment Department, Sustainability Department, Corporate Planning Department, Procurement Department, Finance Department, etc.
Renewable Energy Subcommittee		
Roles	Discussing and implementing initiatives for promoting the company-wide use of renewable energy by utilizing internal technologies, such as storage battery in order to meet the goals of RE100.	Members
		Battery Department, Research and Development Department, Environment Department, etc.
Energy-saving Subcommittee		
Roles	Assess the carbon footprint calculations for each product and promote reducing CO ₂ emissions throughout the Group	Members
		Members of <i>Monozukuri</i> Management Department, Business Department, and Environment Departments and Manufacturing Departments in domestic and overseas subsidiaries

GHG Emissions Reduction Rates and Renewable Energy Implementation Rates - Results and Targets

		FY2020	FY2021	FY2024 (Target)	FY2030 (Target)	Long-term target
Greenhouse gas emissions reduction rate (vs. FY2019)	Scope1 + Scope2	10.8%	13.0%	20%	46%	Carbon neutrality
	Scope3	-	Unchanged	-	27.5%	-
Renewable energy implementation rate		15.4%	21.3%	25%	50%	100% (2050)

Greenhouse gas (GHG) emissions (Unit: kt-CO₂e/year or %)
(Scope: Scope 1 + Scope 2)

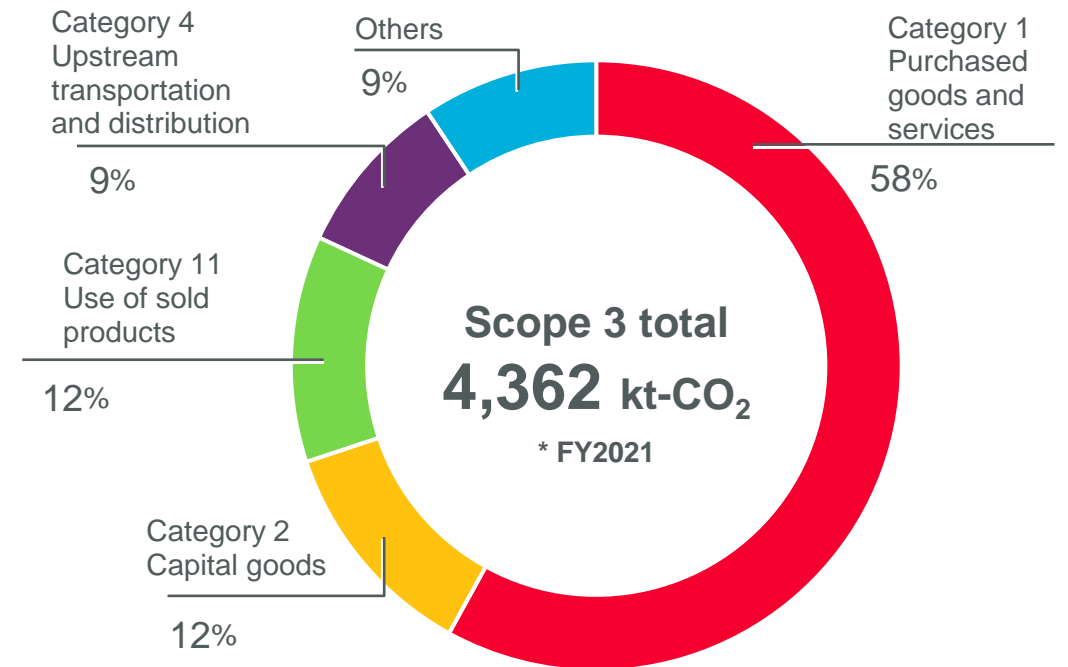
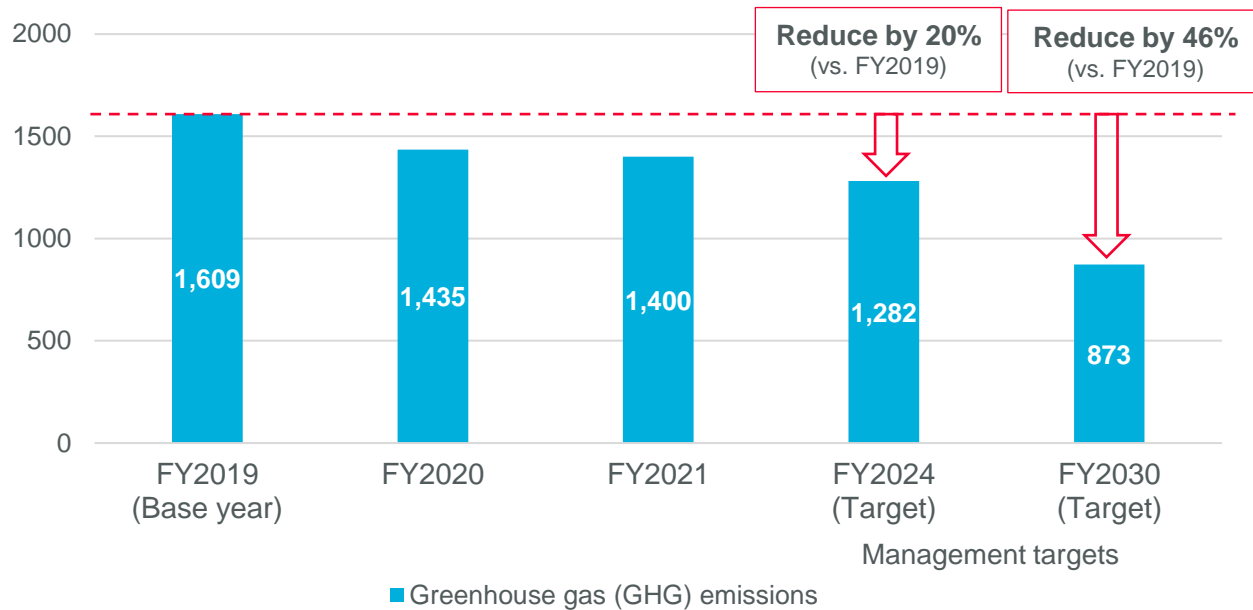

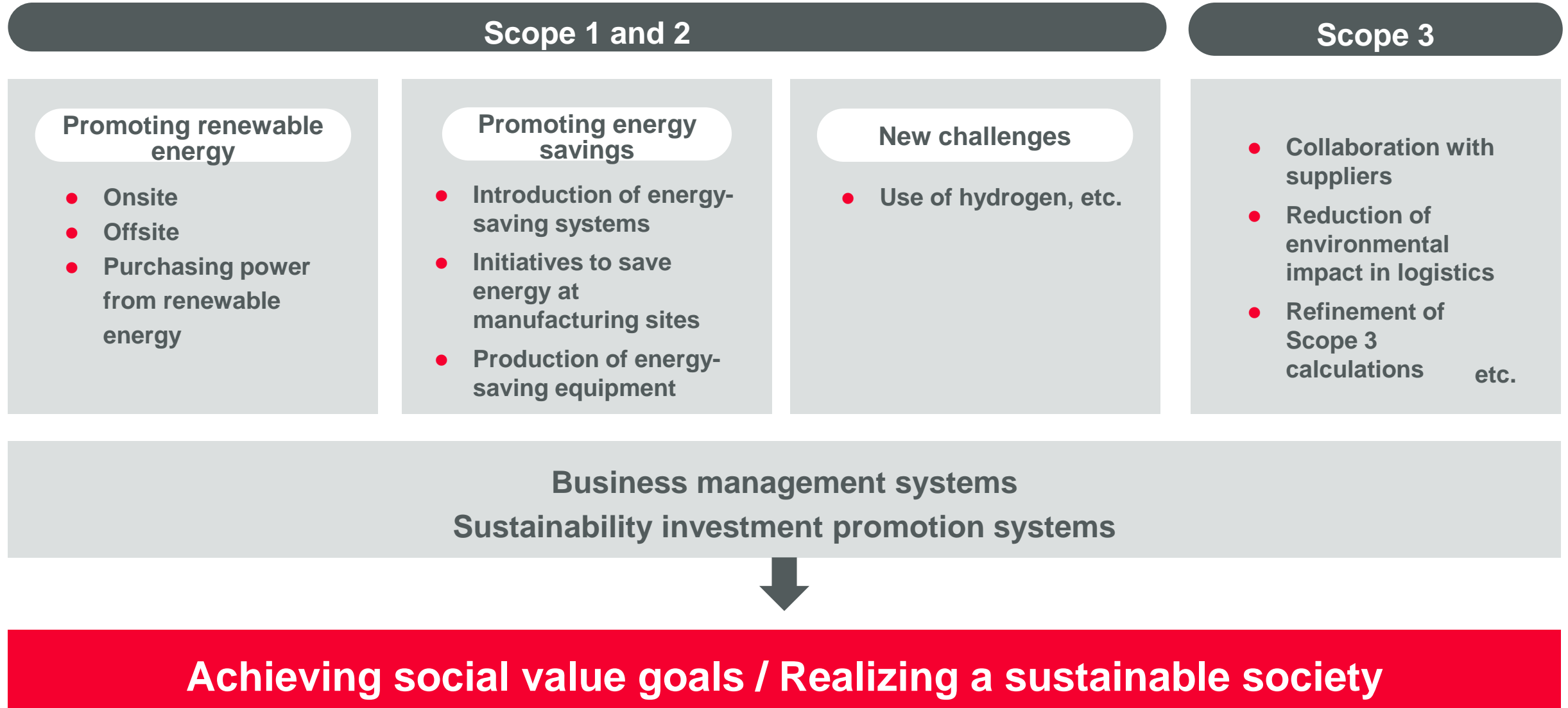

Response to Climate Change - Onsite Renewable Energy Usage Measures

- In addition to solar panels, largescale storage batteries have been installed in plants
- One of the features of this approach: maximizing the benefits of using renewable energy by not simply generating power, but also using storage battery and control technologies

Sites using 100% renewable energy

Kanazu Murata Manufacturing

- Introduced “solar power x storage battery x control system”
- Switched to renewable energy-derived electricity (hydroelectric power)

Solar power



Storage batteries



The Philippines

- Introduced mega solar system
- Switched to renewable energy-derived electricity (geothermal power)

Solar power



Minato MIRAI Innovation Center

- Introduced use of solar power
- Switched to local renewable energy

Solar power



Sendai Murata Manufacturing

- Introduced “solar power x storage battery x control system”
- Switch to renewable energy-derived electricity

Solar power



Storage batteries



Main sites using solar power

Okayama Murata Manufacturing



Hakui Murata Manufacturing



Ise Murata Manufacturing



Wakura Murata Manufacturing



Toyama Murata Manufacturing



Thailand



China



Singapore



Response to Climate Change – Kanazu Murata Manufacturing’s Renewable Energy System

A system that combines solar panels, storage batteries, and control software



Kanazu Murata Manufacturing
Clean Energy Park



Power storage system
that uses Murata cells

Deployment of the system in other plants

- This system has already been introduced in Ise, Wakura, Hakui, and Sendai
- In Sendai, Murata has already begun working with Mitsubishi Corporation on a verification project aimed at stabilizing power systems
- Murata is continuing to deploy this system in other sites, working to achieve the goals of RE100 throughout the Group

Olivine-type lithium iron phosphate lithium ion secondary batteries (FORTELION)

- **Safety**
High thermal stability
Does not lead to thermal runaway
- **Long service and storage life**
Expected service life:
15 years or longer
- **Superior cycle characteristics**

Control technology (efinnos)

efinnos

Control technology used to improve renewable energy usage rates

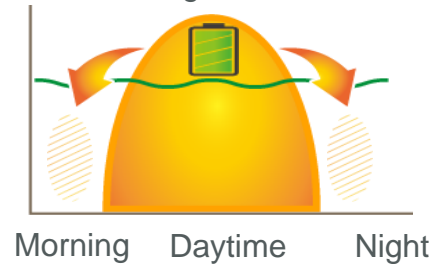

The increased use of distributed power sources has created a new social issue: power grid instability. Murata is using storage batteries and control technologies to address this social issue.

Deployment of this system outside Murata

- Murata is performing internal verification testing and working to commercialize this system and create economic value
- We will also contribute to Scope 3 reductions by proposing the use of this system to suppliers

Response to Climate Change – Promoting Renewable Energy: Offsite PPA

- We aim to achieve the goals set for RE100 by purchasing a steady supply of renewable energy over the long term.
- We work with stakeholders to improve our energy self-sufficiency rate in Japan and contribute to realizing a decarbonized society.

Offsite P-PPA

Murata Manufacturing Group plants located in the Chugoku region



- We concluded an agreement with The Chugoku Electric Power Co., Inc. for the supply of green energy from solar power generation (offsite agreement) and other services.
- All of the Group's production sites in the Chugoku region in Japan will be operating on 50% renewable energy by fiscal 2030.

Offsite V-PPA

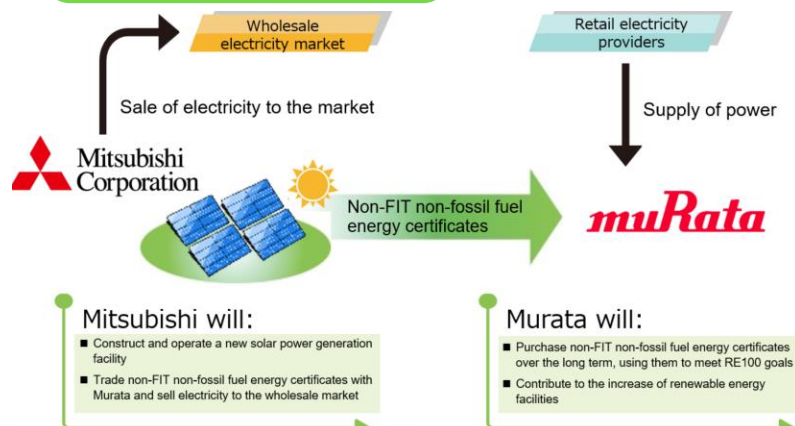

Mitsubishi will:

- Construct and operate a new solar power generation facility
- Trade non-FIT non-fossil fuel energy certificates with Murata and sell electricity to the wholesale market

Murata will:

- Purchase non-FIT non-fossil fuel energy certificates over the long term, using them to meet RE100 goals
- Contribute to the increase of renewable energy facilities

- We agreed to purchase 70,000 kW of renewable energy-derived power from Mitsubishi Corporation by fiscal 2025. Our two companies will continue holding discussions aimed at expanding this to approximately 300 million kWh in the future.
- We purchase power under a virtual PPA (power purchase agreement), which just started being available in Japan. This is the largest initiative of its type in Japan.

Details of collaboration with Mitsubishi Corporation (4 areas)

- (1) Purchasing renewable energy-derived power for Murata Manufacturing
- (2) Hydrogen production and use at Murata Manufacturing plants in Japan
- (3) Economic coexistence with local communities by building an autonomous decentralized community
- (4) Adjusted power using storage batteries

Response to Climate Change - Head Office Energy-Saving System

- We installed an energy-saving system combining AI energy-saving controls manufactured by Mutron, Inc. and Murata's containerized storage batteries at our head office
- Our unique storage battery control technology will enable more flexible controls for saving energy, contributing to reduced energy use
- This system will be installed at all Group sites, including production plants, from 2023 onward

How it controls energy usage

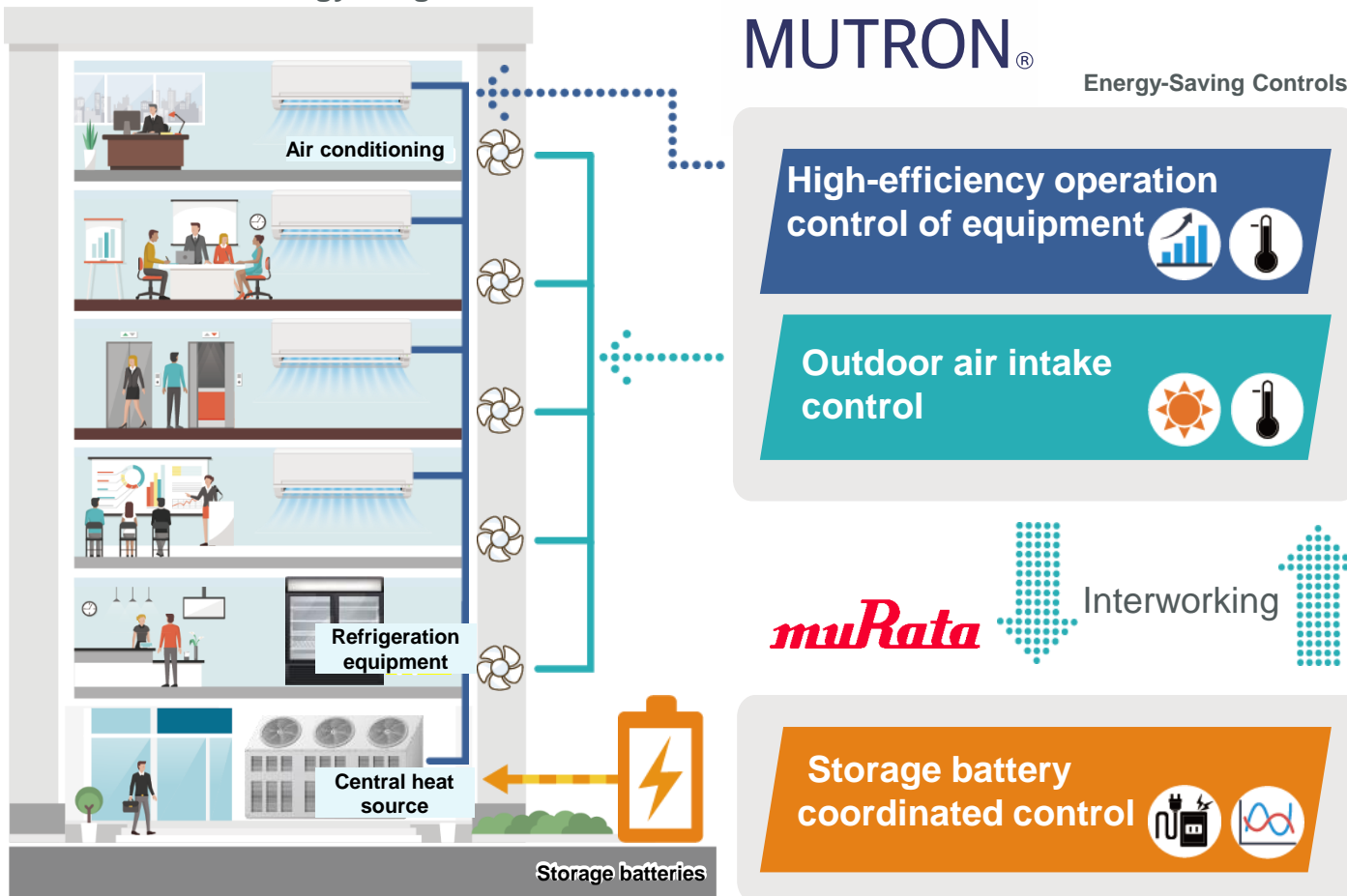

Value created through improved efficiency of energy use

<<Economic value>>

- Reducing energy use reduces energy costs
(Aiming to achieve an energy-saving rate of approximately 20% at its head office in FY2022)
- Deliberation on future commercialization

<<Social value>>

- CO₂ emission reductions
- Helps to reduce the supply load from the power grid and contributes to the stabilization of power supply



Response to Climate Change - Energy-Saving Initiatives at Manufacturing Sites/Production of Energy-Saving Equipment

Energy-saving initiatives at manufacturing sites

Continuously implement 500 to 700 large and small energy-saving measures per year (reduction of 40,000 to 70,000 t-CO₂)

Main energy-saving measures

- (1) Upgrade freezers, etc. to high-efficiency equipment
- (2) Introduce waste heat recovery equipment
- (3) Reduce equipment standby power
- (4) Reduce air conditioning power by optimizing clean room pressurization

Changes in the number of energy-saving measures implemented

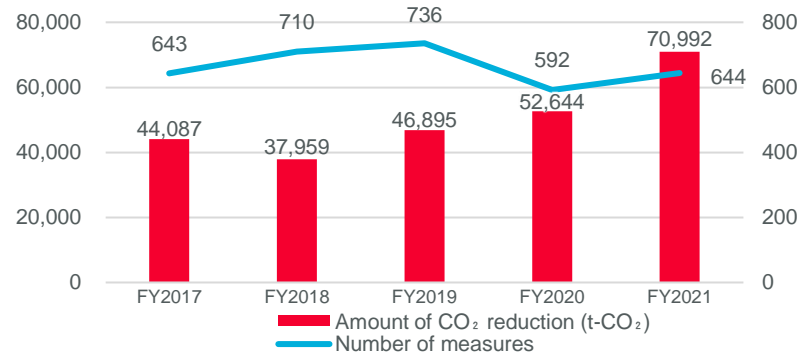

Initiatives at Komoro Murata Manufacturing

To analyze our energy use, we introduced an energy management system that uses wireless sensors to collect data, such as temperature and humidity in factories as well as the current values of other equipment,.



Optimizing air conditioning with energy visualization and reducing equipment standby power

Factory-wide GHG emissions: 2.2% reduction

Production of energy-saving equipment

- Internal manufacturing of production equipment is one of Murata's competitive advantages that contributes not only to economic value but also to social value.
- Integrating design with materials, processing, and production technologies enables us to implement integrated energy-saving initiatives.
- We develop new energy-saving manufacturing equipment with a target of reducing energy consumption by 25% or more compared with benchmark machines (conventional equipment).

Ratio of energy consumption of internally made machines to commercial machines (Comparative energy consumption intensity)

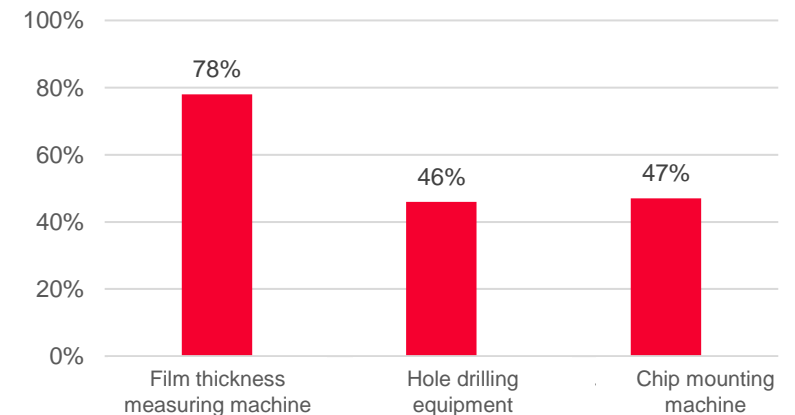

* This data shows a comparison with the time internally made machines were introduced in the past.

Response to Climate Change

- New Challenges to Realize a Decarbonized Society

Challenges for using hydrogen energy

- Progress is expected in the use of hydrogen energy, which has low environmental impact, in order to realize a decarbonized society.
- Anticipating the arrival of a hydrogen society, we will take on the challenge of creating value only possible with Murata.

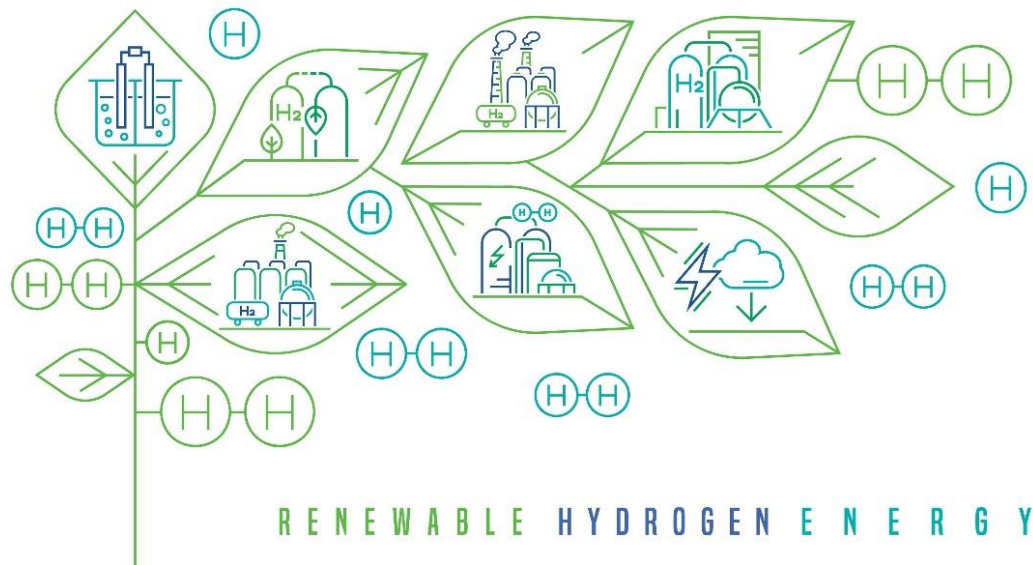

Exploring new possibilities using Murata's elemental technologies

■ Direction of initiatives

Introduction of hydrogen-related facilities

- Preparations are underway to introduce hydrogen-related equipment at our Yasu Division (in Shiga Prefecture). We are also considering connecting to our inhouse renewable energy systems.
- We aim for technology development from a needs perspective by using the features of our Yasu Division, where our manufacturing and development departments are located.

Co-creating value with stakeholders

- In June 2022, we made an agreement to collaborate with Mitsubishi Corporation on hydrogen production and use at our plants.
- We are promoting innovation through collaboration with outside (third-party) companies and organizations.

Purchased goods and services (Category 1)

Issue

The cooperation of suppliers is essential to refining our approach to calculating emission volumes and reducing emissions.

Current initiatives

We are interviewing suppliers of various sizes and a range of business formats about the state of their decarbonization efforts, while providing them with information about Murata's targets and initiatives.

Future initiatives

- We will not simply demand that suppliers implement decarbonization initiatives, but will provide them with support to assist in reducing GHG emissions.
- In the future, we are also considering proposing renewable energy and energy-saving systems for which we have a track record of internal use, along with energy management systems, etc., that use Murata sensors.

➔ We intend to create a continuous cycle of social and economic value by providing support for our suppliers who are responding to climate change

Logistics

■ Modal shift (from April 2023)

We will be switching from trucks to rail for a smaller environmental impact for some of our domestic cargo transport.

We will begin pilot testing on one route, and will then consider adding routes.

This will have the potential to significantly reduce CO₂ emissions in comparison with truck transportation

<Expected benefits: 274 t/year reduction in CO₂ emissions (pilot test)>

■ Elimination of material used for collective packaging (from March 2023)

We will review and revise the sizes of our collective packaging for customers in order to minimize dead space and eliminate the use of cushioning material.



Eliminate the use of cushioning material

This could reduce CO₂ emissions by 33% in comparison with the current packaging design
<Expected benefits: 112 t/year reduction in CO₂ emissions>

Use of Sustainable Resources

Recognized risks
<ul style="list-style-type: none"> Resource depletion Rising prices of mineral resources and plastics Regulatory risks related to the circular economy

Recognized opportunities
<ul style="list-style-type: none"> Reduced raw material costs and waste disposal costs Strengthening business competitiveness by improving customer evaluations Avoiding opportunity losses with stable procurement of resources

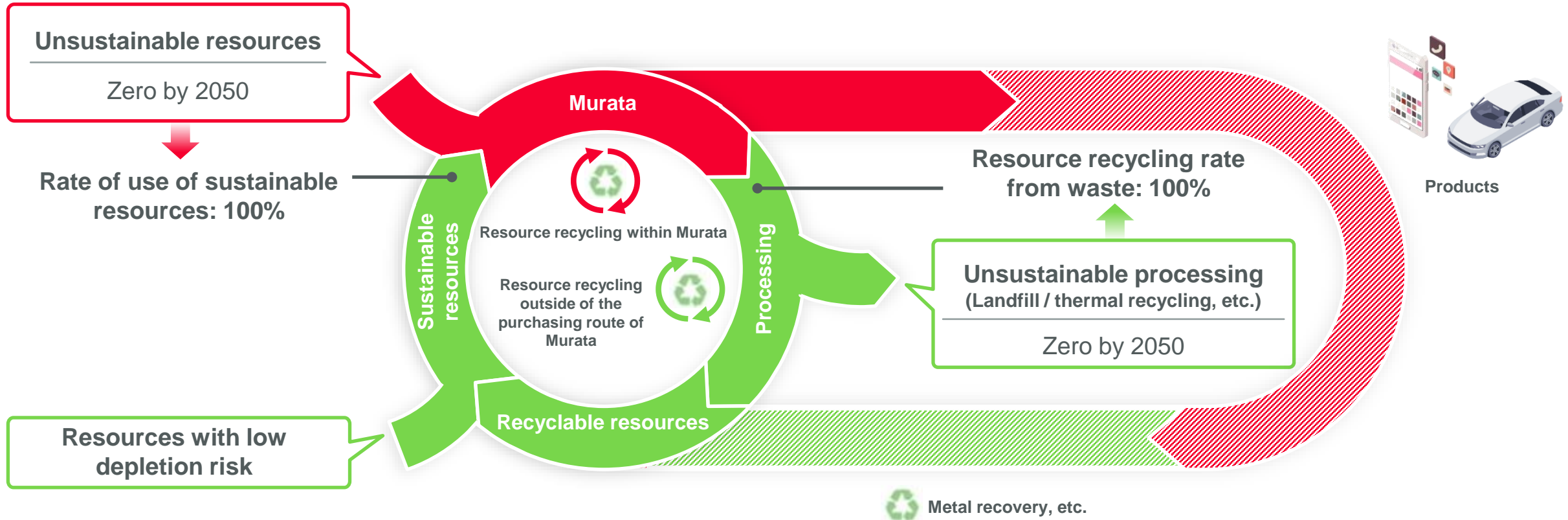

Created the electronic component manufacturing industry's first closed-loop recycling system*

* Recycling process where the polyethylene terephthalate (PET) film used in the multilayer ceramic capacitors (MLCCs) manufacturing process is used again for the same purpose

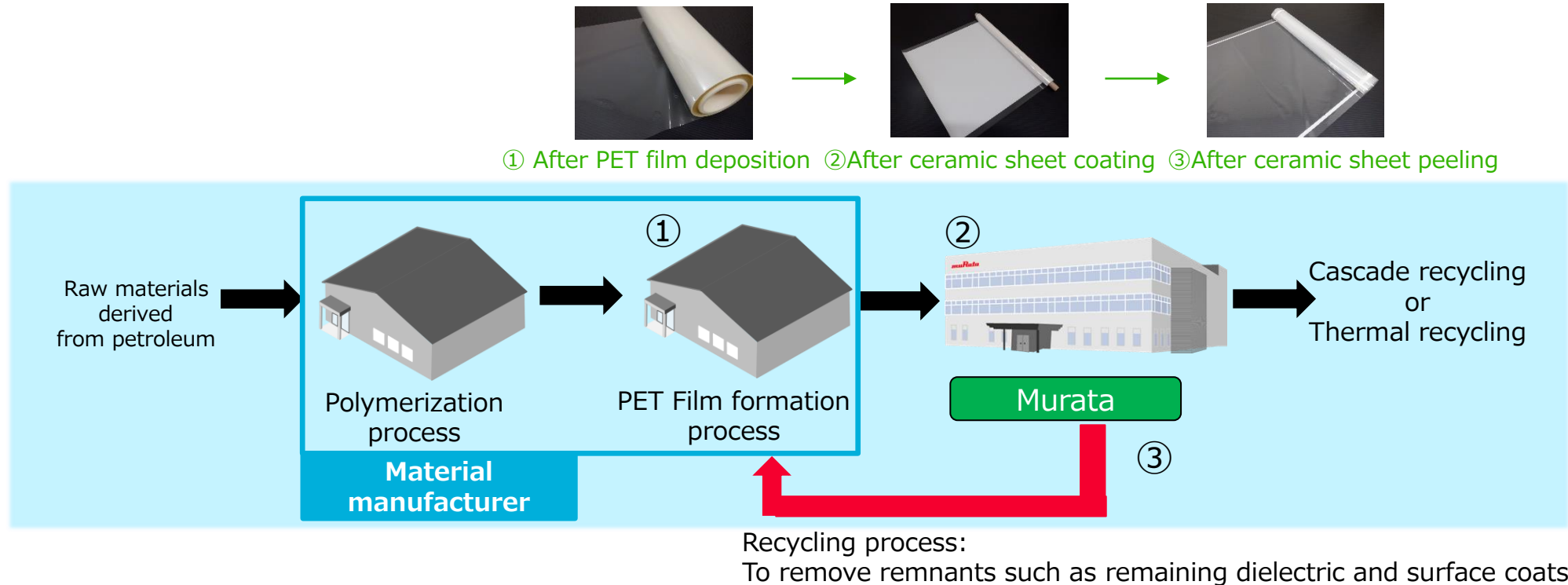

- This system makes the long-term recycling of PET material possible, reducing our environmental impact.
- The current recycled material usage rate for PET film that has been horizontally recycled is around 25%. In the future, we aim to raise this to 100%.
- Through this collaboration with a material manufacturer, we are contributing to the sustainable use of resources and achieving a competitive edge through our pioneering use of this new system, creating a continuous cycle of social and economic value.

04

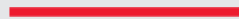

Social

Human Capital Reinforcement Approach

- Under Medium-Term Direction 2024, we intend to strengthen our human capital by taking action listed below

	Issues	Actions
<p>Leverage diversity in human resources to sustain and enhance our collective strength</p>	<ul style="list-style-type: none"> Enable all employees to gain wide-ranging, borderless experience. Enhance the strength of organization through collaboration and cooperation among diverse human resources. 	<ol style="list-style-type: none"> Promote global rotation of employees Acquire diverse personnel with a variety of experience and leverage the diversity Provide a variety of career paths Promote women's participation
<p>Employee engagement that is born when employees are motivated and feel they are growing</p>	<ul style="list-style-type: none"> Enable employees to act autonomously for overall optimization. Ensure that employees can work in safety and peace of mind. 	<ol style="list-style-type: none"> Use global survey to improve the organizational culture Encourage conversation between top management and employees Establish employee-friendly work environments and systems Provide safe and secure workplaces and practice health management
<p>Acquiring and developing human resources to respond to a changing business environment</p>	<ul style="list-style-type: none"> Acquire, develop, and deploy human resources to achieve Vision 2030. Prepare management for the future. 	<ol style="list-style-type: none"> Attracting and acquiring human resources Develop human resources Continual training of candidates for next generation of management Acquire and develop employees for DX (digital transformation)

Promotion of Diverse Human Resources - Percentage of Overseas Indirect Employees with Experience Working at Other Sites

Background

We will promote the success of our diverse human resources and the enhancement of our employees' abilities and organizational strength through our initiatives aimed at increasing the percentage of employees with experience working at other sites. At the same time, with the anticipated future labor shortage in Japan, we will strengthen our human resources in overseas sites, promote global coordination to expand production overseas and strengthen our frontline capabilities, leading to increased economic value.

Percentage of overseas indirect employees with experience working at other sites (FY2021)

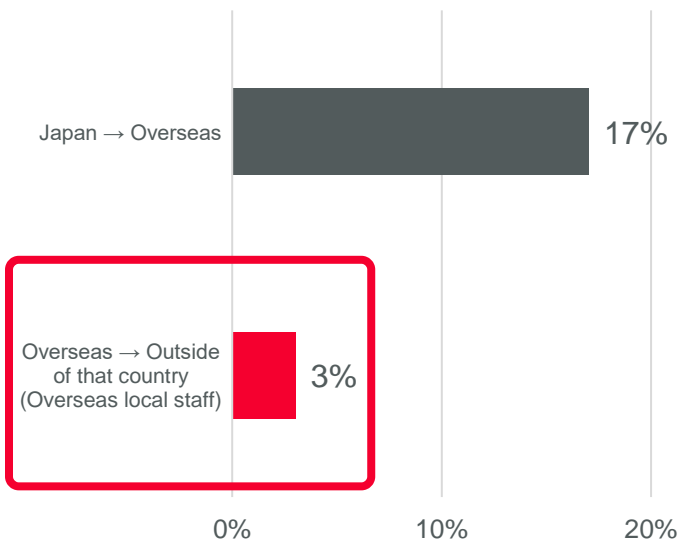

Percentage of overseas indirect employees* with experience working at other sites

FY2021: 3%
FY2024: 7%
FY2030: 10%

* Applies to overseas local staff, excluding those transferred from Japan to overseas

Systems

- Diverse dispatching programs for employees from overseas
- Personnel registration system for employees from overseas
- Improved pre-dispatch training, including language training
- Create positive working environments for employees from overseas

Examples

1 Dissemination of the management philosophy

Employees from companies acquired through M&As are brought to Japan, and then take management positions when they return to their home country. They will contribute to the dissemination of the Murata Philosophy and Murata's corporate culture in overseas sites.

2 Improved overseas production

Employees from overseas sites are brought to Japan in preparation for relocation of production processes to overseas locations and more production at overseas sites. They learn about the systems and technologies used in the Japanese plants, developing into key personnel for overseas development.

Promotion of Diverse Human Resources

- Promote women's participation

Promoting women in management positions

Percentage of women in management positions

(Murata Manufacturing Co., Ltd. on a non-consolidated basis, fiscal year)

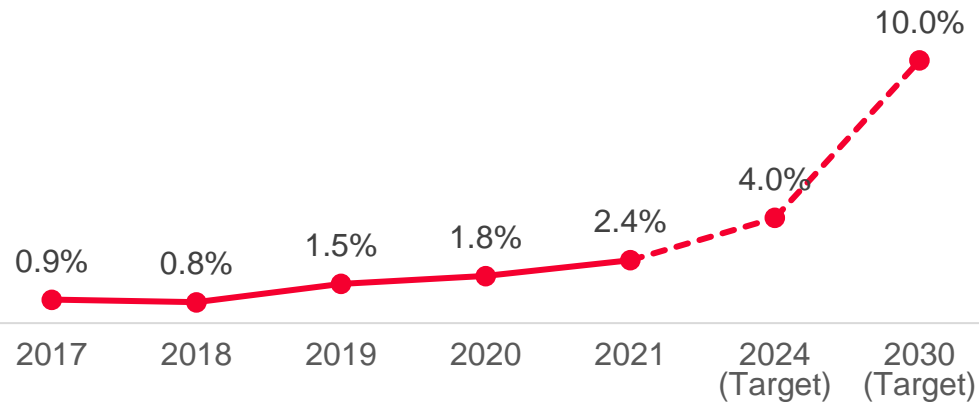

Hiring

Our target for women in technical fields through career-track hiring is at least 10%.

	FY2019	FY2020	FY2021
Percentage of women among all employees	21.4%	22.0%	22.7%
Percentage of women in technical fields through career-track hiring	15.8%	13.0%	14.9%

* Murata Manufacturing Co., Ltd. on a non-consolidated basis

Changing attitudes

Dialogue between President Nakajima and Director Yasuda



President
Norio Nakajima



Outside Director
Yuko Yasuda

Panel discussion



Women in management positions and Outside Director Yasuda

Together they communicate to employees the sincere attitude of the President and the active participation of women in management positions, working to change attitudes within the Company.

Systems

- Create environments and systems that make it easier for both men and women to work with changes in their life stages, such as by reviewing the flextime system, remote work, and the system for taking leave to accompany a spouse overseas*1
- Encourage male employees to take spousal maternity leave (special paid leave) and childcare leave

*1 Allowing employees to take up to 3 years of leave to accompany a spouse on an overseas transfer.

Percentage of male employees taking childcare leave	18.2%
Average number of days of childcare leave taken by male employees	46 days

* Fiscal 2021 results, Murata Manufacturing Co., Ltd. on a non-consolidated basis

M-DIP activities



M-DIP (Murata Diversity on Inclusion Plaza) is a committee that began in 2016 to further promote D&I (diversity and inclusion) by leveraging the diverse knowledge, abilities, and perspectives of employees. Every year, Company employees who apply for committee positions work on promoting D&I.

Past activities

1st year

Defined Murata's D&I vision

2nd through 4th year

Implemented measures aimed at firmly establishing D&I concepts within the Company
Put up posters, held lectures, conducted dialogues, and performed other activities aimed at fostering more D&I penetration

5th year and onward

Created D&I workplace use and application tools with the mission of "creating more workplaces where everyone expresses their ideas and thinking as they work together toward common goals"
Created videos of interviews with the President and videos introducing workplace D&I activities, tools for holding D&I workshops, etc.

D&I drives innovation. Through the M-DIP's activities, we are firmly rooting the concepts of D&I within the Company, promoting innovation while improving the ES of every employee. We are linking these initiatives to improving our organizational strength and increasing our corporate value.

Overview of Murata Global Survey 2021

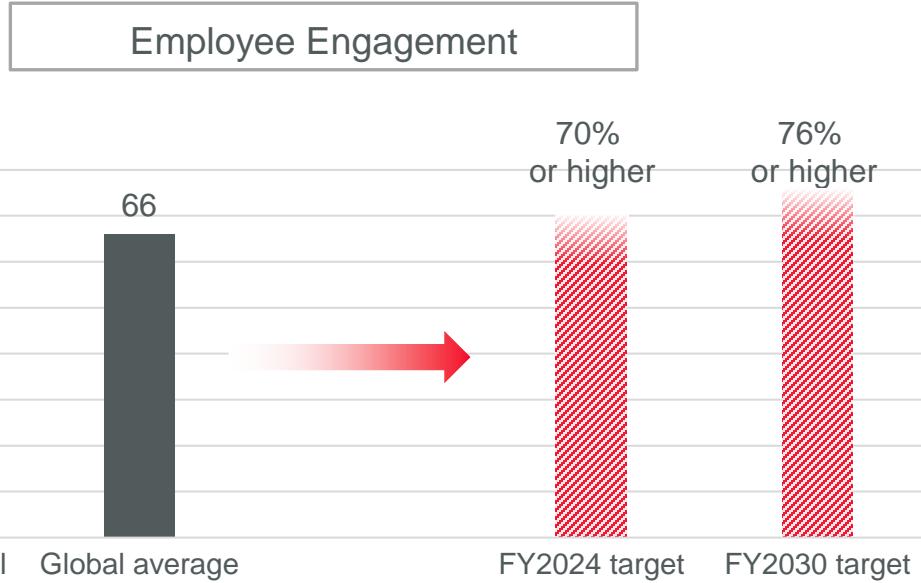

- Overseas scores are higher than the global average but Japanese scores are lower
- The results for Japan are indicated below:

Strengths	Areas requiring improvement
<ul style="list-style-type: none"> • Remuneration and benefits • Leadership • Growth opportunities, education, and training 	<ul style="list-style-type: none"> • Authority and discretionary power • Resources • Cooperative structure

Item	FY2021
No. of employees surveyed	Approx. 75,000 Japan: Approx. 33,000 Overseas: Approx. 42,000
No. of participating sites	57
Analysis layers	The smallest analyzed unit was the division 2,609
Survey period	Oct. 5, 2021 to Oct. 28, 2021
Ultimate response rate	95%

Survey company: Korn Ferry

Types of employees for which concerted measures must be taken to improve scores

- Mid-career hires
- Senior employees
- Manufacturing department employees

Measures for specific types of employee

Mid-career hires

- Improve matching through discussions with the departments that employees are to be assigned to before making informal hiring decisions
- Conduct initial questionnaire three months after employees join the Company
- Conduct training using the Murata Innovation Museum six months after employees join the Company

Senior employees

- Use open application system to enrich workstyles and assignment destinations
- Conduct career training for employees aged 50 and older
- Make necessary changes related to compulsory retirement age: 65

Manufacturing department employees

- Grand design (large picture) activities at individual manufacturing sites
- Develop career paths for manufacturing personnel
- Strengthen dialogues between management and employees working in the field

Percentage of management personnel that are mid-career hires
(including employees acquired through M&As, domestic only, by fiscal year)

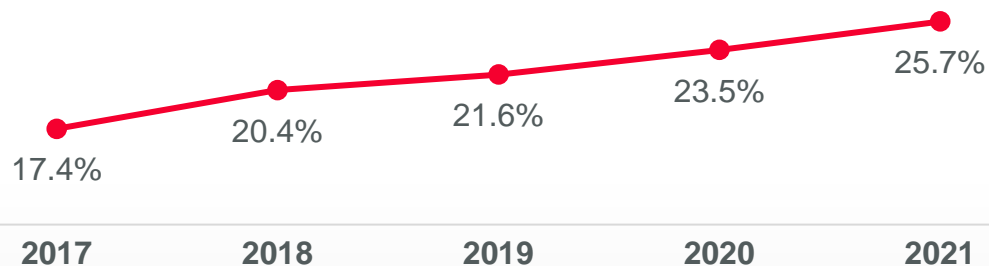

Promote innovation by preparing an environment where employees with diverse experience and backgrounds can thrive

Site visits by top management

Every year, top management visit sites in Japan and overseas, providing opportunities for dialogues with local employees

FY2022 results

Chairman Murata: 25 sites
President Nakajima: 19 sites



Engagement - Examples of Reforming the Corporate Culture

In 2004, when the dot-com bubble burst, we saw an opportunity to start reforming our corporate culture. This reforming continues with new and improved initiatives.

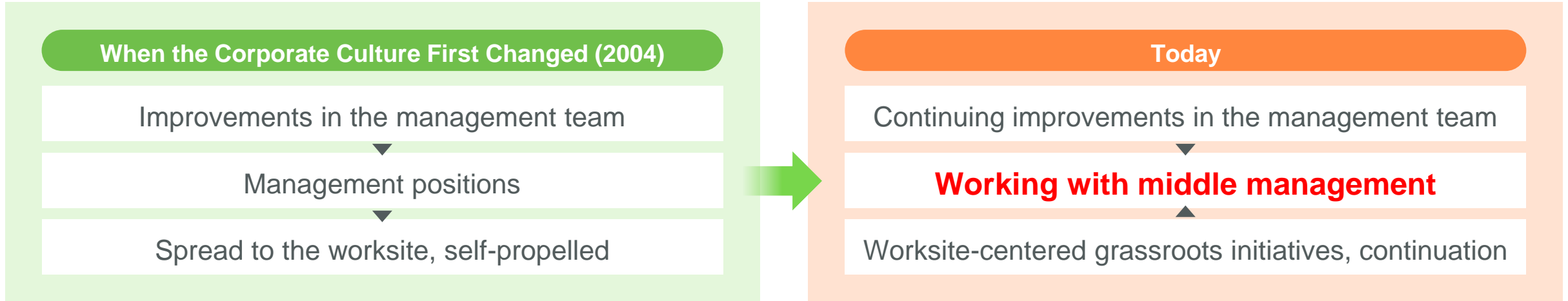

Example of worksite-centered initiatives

1 “One Cap!” activities of the Capacitor Division

In Murata’s largest business division, this initiative is undertaken to deepen exchanges between employees, including top management, and to change the organizational culture with participants taking the lead.

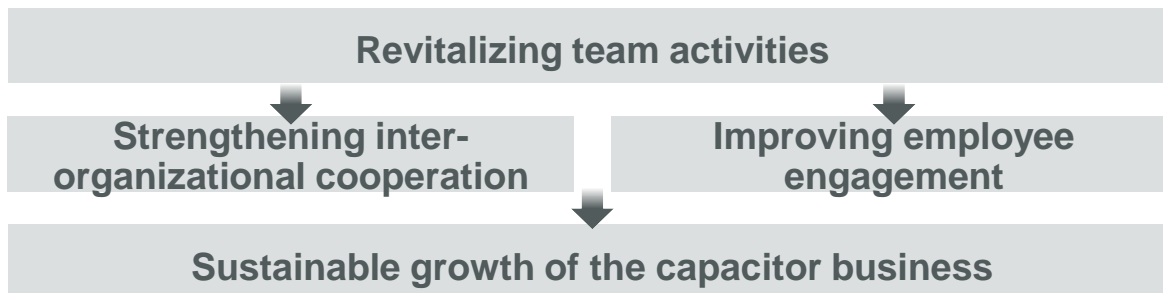

2 Worksite Improvement facilitators Conference

This activity is aimed at fostering a corporate culture of worksite improvement by sharing good examples of worksite-centered improvement initiatives at each manufacturing base with the management team and manufacturing bases within the Murata Group.

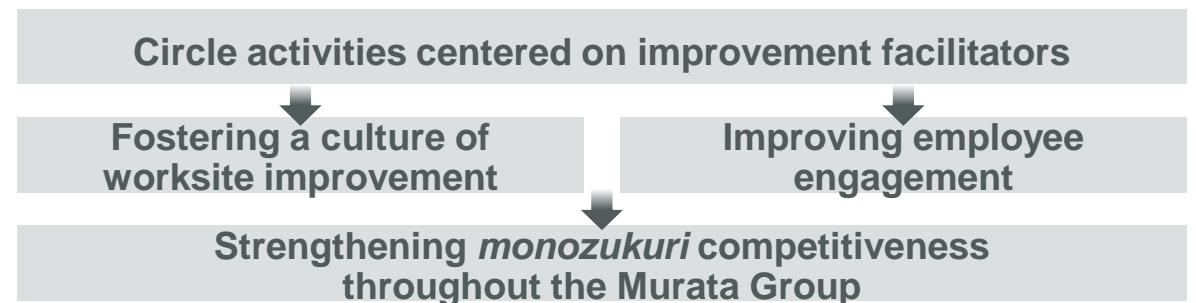

Acquiring and Developing Human Resources - Developing *Monozukuri* Employees

- For Murata, as a manufacturer, manufacturing sites are the wellspring of value creation, so the development of *monozukuri* employees is an important task.
- Murata devotes special attention to developing *monozukuri* employees for worksite improvement as well as maintenance engineer who are responsible for equipment maintenance.

The human resources that support *monozukuri* sites

Worksite improvement facilitators

- Worksite improvement employees, who specialize in improvement technologies (*kaizen*) that support our competitiveness in *monozukuri*, are primarily manufacturing supervisors and workers on the front lines at manufacturing sites. They are remarkable for their implementation of scientific management techniques and the fact that they steadily produce improvements.
- We focus on providing them with wide-ranging experience so that they develop diverse perspectives and skills.

No. of worksite improvement facilitators (consolidated)

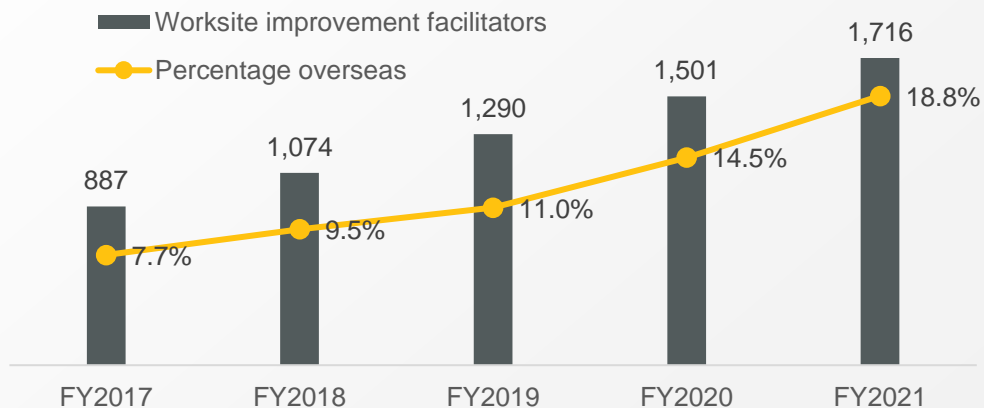

Maintenance engineer

- Maintenance engineer are essential for Murata's equipment-focused processes, as they help ensure that factories operate steadily and maintain supply capabilities, one of Murata's strengths.
- We write down and standardize maintenance skills, which take a lot of time to acquire, and reinforce our development of maintenance engineer through maintenance training rooms at our main production sites.

No. of maintenance engineer (consolidated)

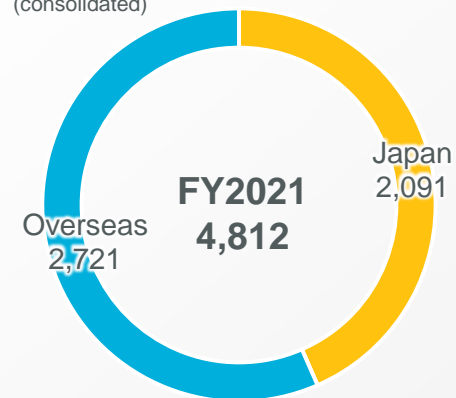

In the maintenance training room

Initiatives for Acquiring and Developing Human Resources - Level-Specific Training Program

- During their first year with the company, and as members of the manufacturing industry, employees take part in factory hands-on training to learn how interesting *monozukuri* is and gain an understanding of areas of dedication at manufacturing sites.
- We have developed level-specific training programs for nurturing candidates who will become corporate executives in the future.

Executives

①

1. For corporate executive candidates

- Our two-year selective training program in Japan and overseas promotes the self-transformation of participants into leadership roles.
- Participants work directly not only with their immediate superiors, but with multiple executives, and we provide opportunities for their active growth.

Rate of promotion to senior management positions among participants in selective training (in Japan/cumulative)

Fiscal Year	Rate (%)
FY2017	26.3%
FY2018	20.7%
FY2019	20.5%
FY2020	32.7%
FY2021	49.2%

Management position

②

2. For mid-level leaders

- We have set up programs for developing next-generation corporate executive candidates.

Make2030	A program that provides experience at an early stage to heighten sensitivity to changes in the environment, to promote coordination throughout the organization, and to have participants link their self-directed thinking and behavior with the future of the company
Global Program	A human resource development and reinforcement program that helps to develop employees who can contribute to business growth from a company-wide perspective while adopting the Murata Philosophy

General staff

③

3. For new graduates

- All new graduates take part in factory hands-on training (for approximately six months). The goal is to teach them about our dedication to safety, quality, and cost at manufacturing sites, the value of teamwork, and the sources of Murata's value creation.
- Much time is invested in new graduates. We have high expectations from them for growth, in order to reinforce our human capital.

Number of factory hands-on training participants (people)

Cumulative total: 3,020

Fiscal Year	Participants (people)
FY2009	120
FY2010	60
FY2011	72
FY2012	121
FY2013	134
FY2014	134
FY2015	152
FY2016	234
FY2017	261
FY2018	339
FY2019	370
FY2020	389
FY2021	306
FY2022	328

Copyright © Murata Manufacturing Co., Ltd. All rights reserved.

Human Rights and Labor Policies

Main Points

- Endorsing the International Bill of Human Rights and the ILO Declaration on Fundamental Principles and Rights at Work
- Conducting human rights due diligence
- Supporting business partners
- Prohibiting discrimination and harassment
- Prohibiting forced labor
- Prohibiting child labor, restrictions on employment of young workers
- Respect for the rights of labor organizations
- Ensuring suitable working conditions

■ Percentage of staff who have received training on human rights

	General education	Manager education
Overall (on a domestic consolidated basis)	95.4%	96.4%

* Percentage of domestic employees who have taken e-learning courses

Initiatives related to respect for human rights

- 2002 • Established the Corporate Ethics Policy and Code of Conduct
- 2009 • Established the CSR Charter
• Promoted the RBA Code of Conduct in the Procurement Policy
- 2012 • Established the Human Rights and Labor Policies
- 2013 • Started using CMRT for response
- 2015 • Established the Human Rights Management Manual and started operation of the Human Rights and Labor Committee
- 2016 • Requested existing suppliers to conduct self-assessments
- 2019 • Renewed the Human Rights and Labor Policies through societal demands and dialogue with stakeholders
• Started using CRT for response
- 2020 • Conducted company-wide human rights risk assessments
• Increased compliance consultation hotlines (added harassment consultation hotlines)
- 2021 • Held lectures on human rights by outside experts for all employees
• Established a risk assessment process for new business partners
- 2022 • Joined the RBA
• Conducted regular audits of existing suppliers
• Responded to new minerals, such as mica
- 2023 • Establish the Human Rights Committee on the CSR Management Committee (planned)

Respect for Human Rights - Human Rights Due Diligence

PDCA cycle for human rights due diligence

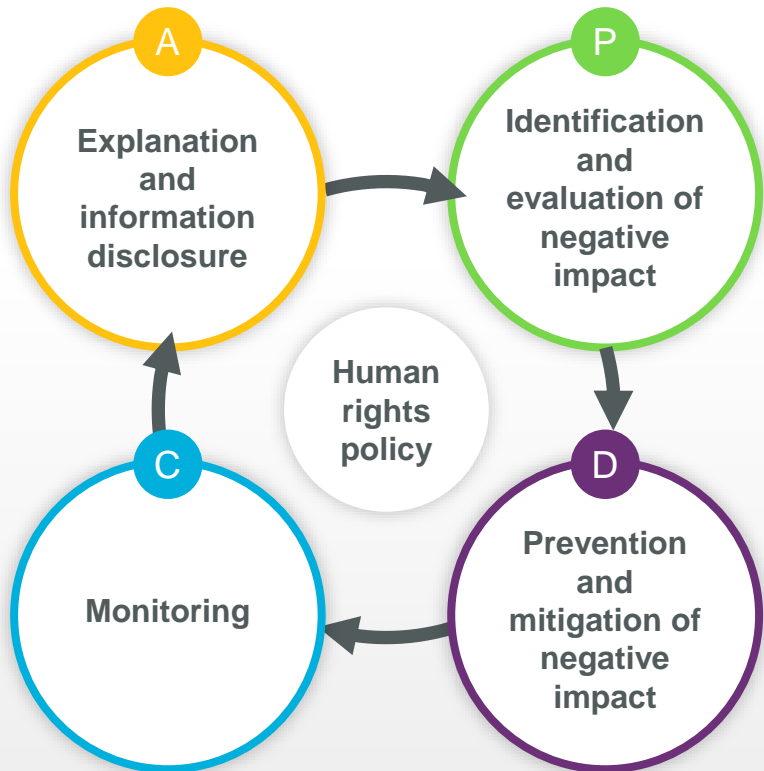

Identification and evaluation of negative impact

Company-wide risk assessment was conducted in fiscal 2020. Analysis was made of potential human rights risks throughout our operations.

Prevention and mitigation of negative impact

Examples of specific initiatives

Murata: To cut back on long working hours during busy periods for engineers in key businesses, we established a labor-management consultative body that included labor unions, business divisions, and personnel departments. We also implement quarterly monitoring of the progress of business plans and actual working hours. (Overtime hours for engineers in target departments was reduced by 16% year on year in fiscal 2021)

Suppliers: We conduct regular audits of suppliers, helped them to make improvements, and evaluate high-risk minerals (cobalt, etc.) using the OECD due diligence process.

Monitoring

Current monitoring systems

Murata: We monitor work conditions and work hours, and hold dialogues with labor unions, etc.

Suppliers: We have built a system for the risk assessment of our suppliers.

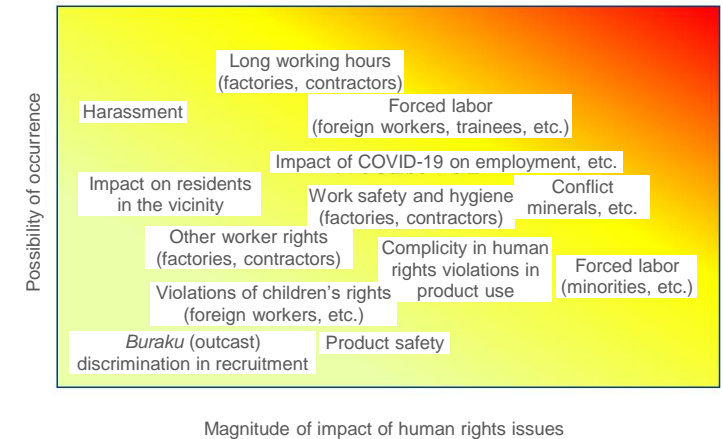

Explanation and information disclosure

We disclose information through our website and integrated report (Murata value report).

1 CSR procurement

Basic views

- Mutually satisfying and prosperous relationships with suppliers
- In addition to the efforts we have been making to coordinate with suppliers for quality, we are also enhancing our supplier coordination for social issues
- As an RBA member company, we contribute to the achievement of a sustainable society throughout our supply chain

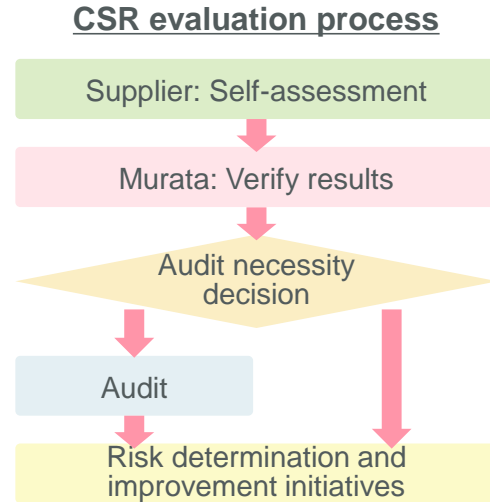

Targets

KPI	Targets for FY2022 to FY2024
Rate of agreement signed for compliance with the CSR Procurement Guidelines for Murata Group supply chain	95% worldwide
Ratio of CSR evaluation improvement	100% improvement of all suppliers needing corrective action
Ratio of CSR audit execution	95% execution rate of CSR audits on important suppliers

2 Responsible initiatives related to conflict minerals

To reduce the Annex II risks in CAHRAs, such as human rights violations, Murata is committed to the following initiatives in compliance with the OECD Due Diligence Guidance for 3TG,* cobalt, and other minerals used in our products, which are potential conflict minerals with a high degree of human rights risk.

5-Steps for OECD Due Diligence Guidance

* 3TG: Tin, tantalum, tungsten, and gold

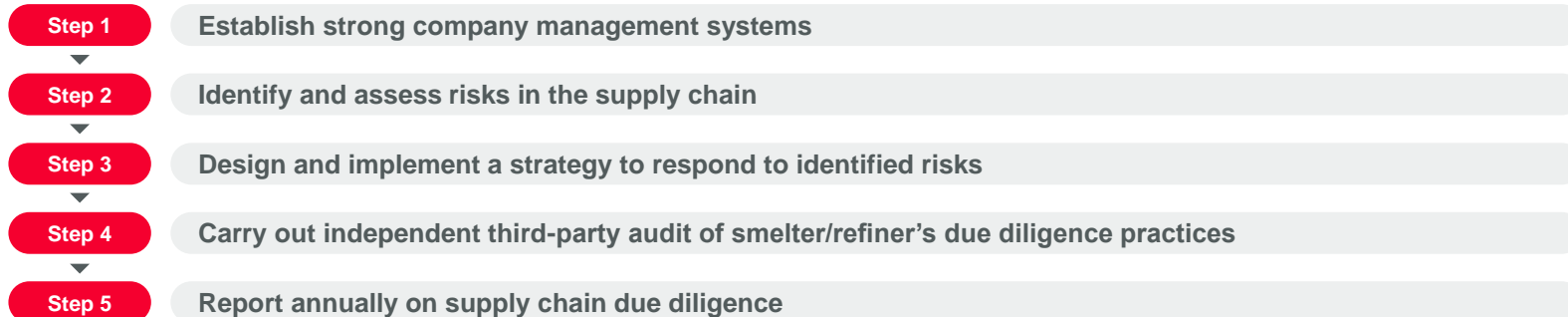

FY2021 conflict mineral survey results

- Conducted survey of 154 major suppliers handling 3TG* (response rate: 100%)
- Conducted survey of 91 major suppliers of cobalt (response rate: 86%)
- Identified 420 smelters and confirmed that 327 are RMAP conformant smelters
- Confirmed, based on past conflict mineral surveys, that Murata's multilayer ceramic capacitors, inductors, etc. are conflict free

Contributing to regional revitalization

In Izumo City, Shimane Prefecture, Izumo Murata Manufacturing, Shimane Fujitsu, and Shimane Shimadzu have launched a collaborative regional revitalization project.

In prefectural areas with shrinking working populations, overall region growth is essential for being able to keep conducting business. Local companies in this project are coordinating closely with each other to contribute to sustainable urban development and a continuous cycle of business growth.







Contributing to society through sports

In November 2022, Murata signed an affiliation contract with professional golfer Haruka Kawasaki (who comes from Kyoto).

By supporting young people from Kyoto who are taking on the world, Murata is raising the morale of employees and contributing to regional revitalization.



Support for multicultural harmony within the community

Fukui Murata Manufacturing is supporting multicultural harmony within the community through activities such as sending out interpreters and donating supplies to elementary schools and junior high schools with many Brazilian children of Japanese descent.



Fukui Murata Manufacturing (Japan) is helping with sending access workers (interpreters) to assist students who cannot speak Japanese

Visiting classes

Murata conducts science classes and provides visiting classes to elementary school students with the aim of teaching them about the nature of the work done by engineers, who form the backbone of *monozukuri* (manufacturing), and about what makes being an engineer so interesting.

Supporting the development of the human resources of the future



Visiting classes being conducted at Murata Energy Device Wuxi Co., Ltd. (China)

05

Governance

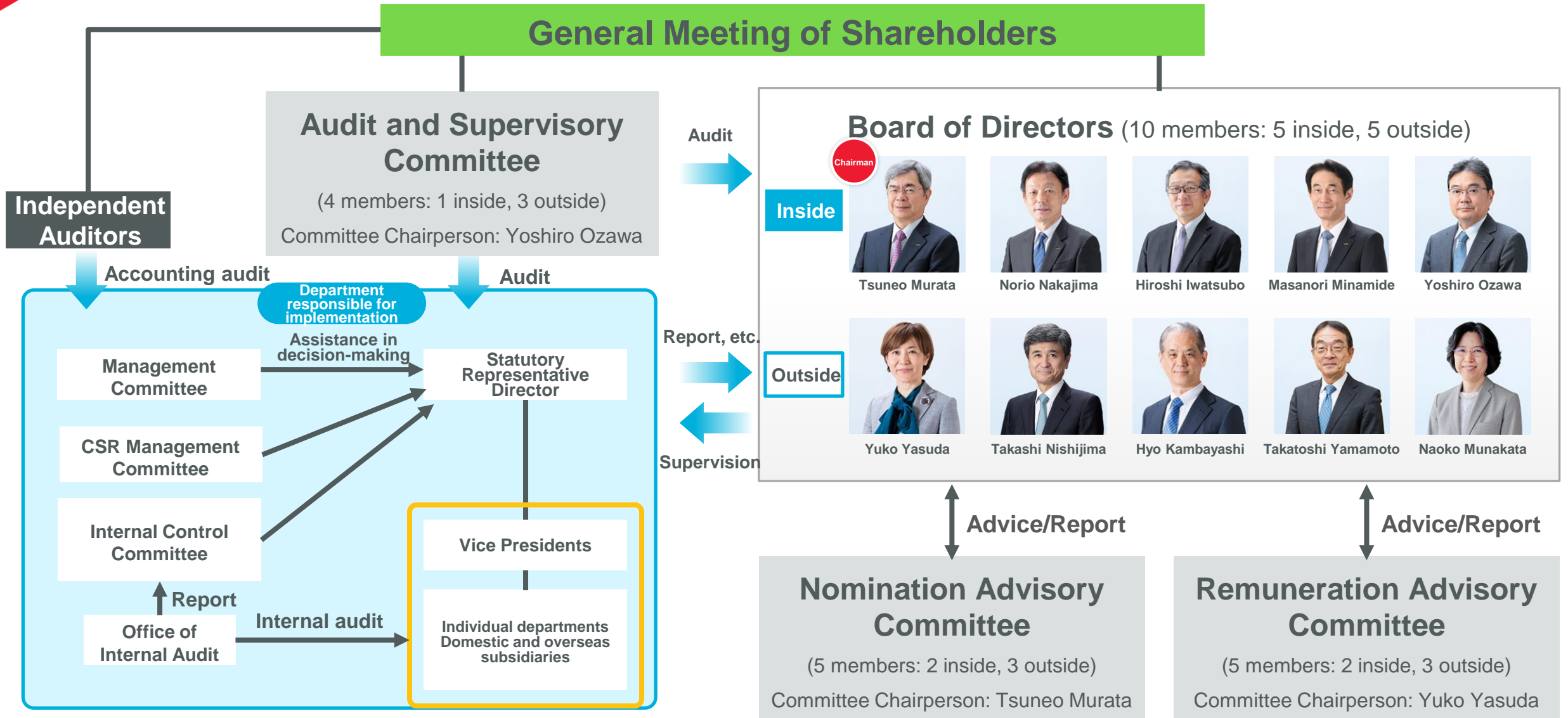

Initiatives for Ensuring the Effectiveness of the Board of Directors

Challenges and problems identified in the evaluation of effectiveness for FY2021

- Further enhance and energize Board of Directors' discussions to make them more strategic and to take a wider perspective
- Eliminate the information gap between inside directors and outside directors
- Facilitate smooth communications among directors



Initiatives in FY2022

- Strike balance between the decision-making, supervisory, and advisory functions of the Board of Directors
- Arranging and employing off-site meetings

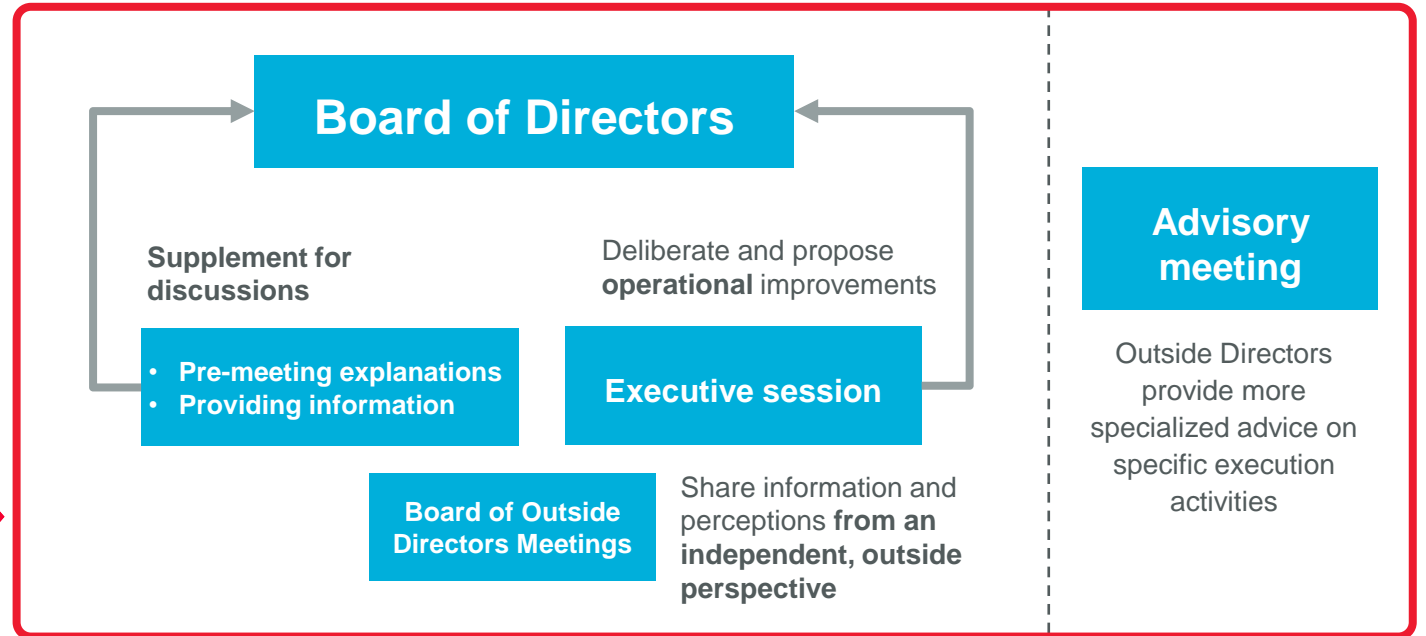

Pre-meeting explanations	Opportunities to provide Outside Directors with explanations of proposals and for departments responsible for implementation to provide internal information
Providing information	
Executive session	Sessions held after Board of Directors meetings to deliberate on improvements to Board of Directors meeting operations and to issue proposals, etc. (attended by all Directors, both inside and outside)
Board of Outside Directors Meetings	Meetings exclusively for Outside Directors. Opportunities to share information and perceptions from an independent, outside perspective

Executive Remuneration System

Key points of the executive remuneration system

- Remuneration for Members of the Board of Directors who are not Audit and Supervisory Committee Members is made up of:
 - Monthly remuneration
 - Bonus with the aim of providing a short-term incentive
 - Share-based remuneration
- Share-based remuneration is provided through restricted shares allotted with the aim of increasing the willingness of Directors to contribute to the continuous improvement of corporate value from a standpoint aligned with shareholders
- From FY2022, **the achievement of social value goals outlined in the Medium-term Direction 2024 is reflected in share-based remuneration**
- Establishment MARS clawback clause

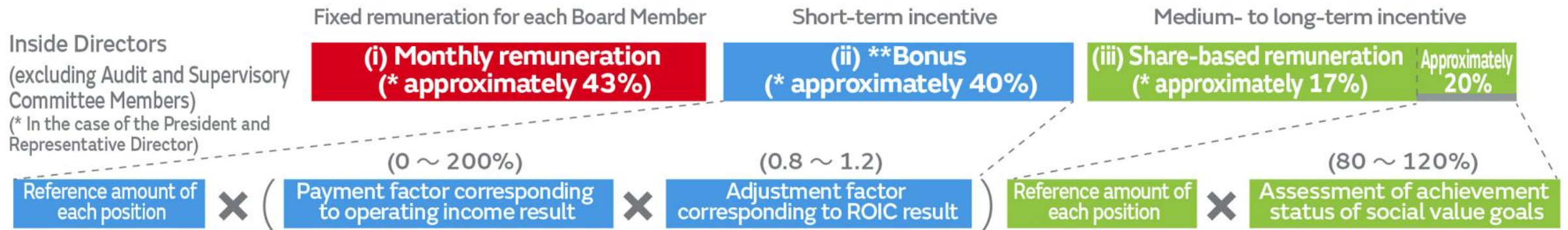

** Bonuses are variable within the range of 0 - 200% of the reference amount of each position.

Ensuring objectivity and transparency when determining remuneration

- The chairperson of the Remuneration Advisory Committee is an Outside Director. A majority of the Committee are Outside Directors.
- The validity of the standards and composition ratios of monthly remuneration, bonuses, and share-based remuneration is verified using a database operated by an external consultant.
- Establishment of shareholding guidelines for Members of the Board of Directors.

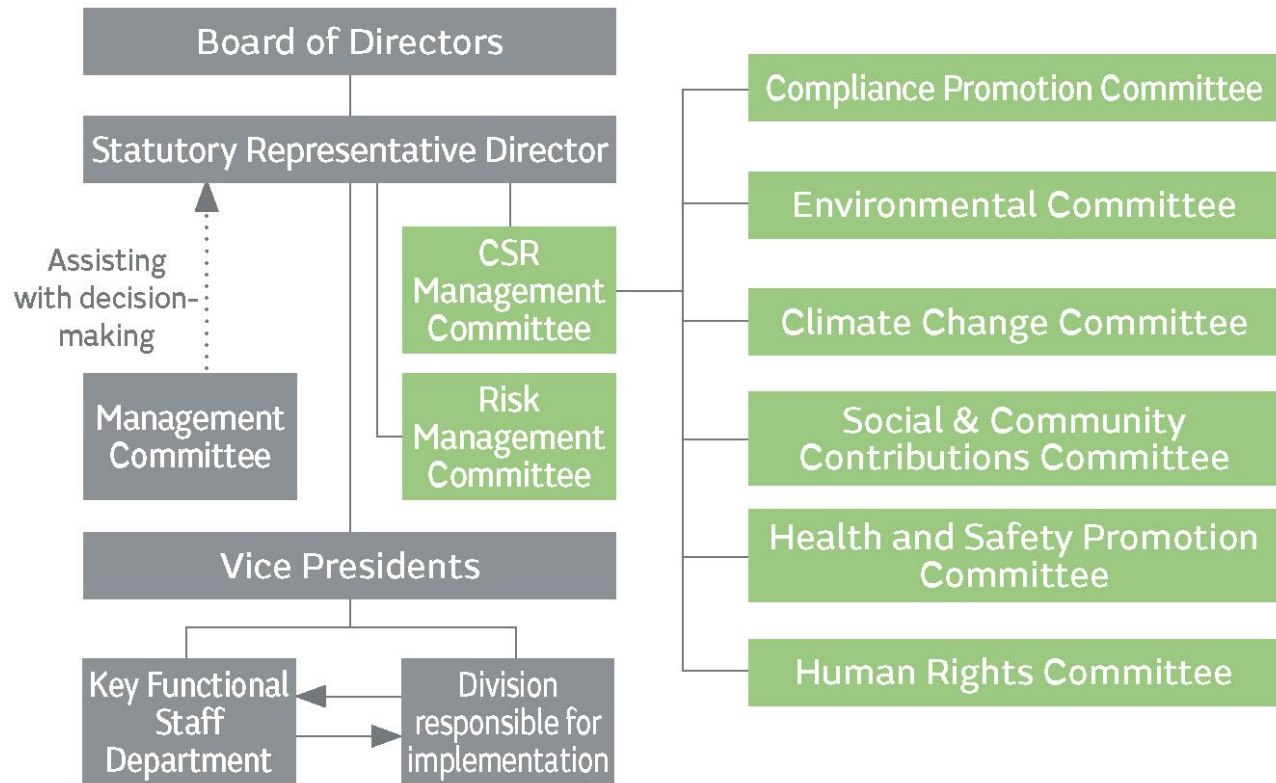

CSR Management Committee

The CSR Management Committee was established to continually and systematically promote CSR management, including initiatives related to sustainability, to further ingrain CSR within the Company, and to centrally handle issues from outside the Company.

Main activities of the CSR Management Committee (FY2022)

- Deliberated on becoming a member of the RBA. Murata became a regular member in June.
- Established a Human Rights Subcommittee within the CSR Management Committee to systematically deal with human rights issues throughout the Company.

Examples of agenda items related to ESG at the Board of Directors meetings

- Deciding on key issues (materiality), reporting on their status and initiatives
- Advisory committee reporting and activity reporting, evaluation of the effectiveness of the Board of Directors
- Intellectual property and human capital issues
- IR activities and dialogue with shareholders, etc.

* As of April 2023 (planned)

Features of Murata's business management system

- Transparent accountability system (clarifying the responsibilities and authorities of business divisions, financially independent subsidiary system)
- Profit and loss management system that enables evaluations in detailed units for each product and each production process
- Management accounting system that applies an internal interest rate that is higher than the cost of capital
- Investment economics evaluation that considers return on investment and the payback period
- Assessment of business feasibility based on two axes: ROIC and market growth rate

Aim for sustainable growth

Improving organizational strengths

- Practice autonomous, decentralized organization management
- Manage in response to changes based on hypothetical thinking
- Enhance supervisory functions and mechanisms of the Board of Directors

Promoting sustainability

Introduce a sustainability investment promotion system

Point

1 Use mechanisms to encourage sustainability investment

- Relax criteria for the payback period of sustainability investment
- Establish a special case certification system for sustainability investment

Point

2 Apply an internal carbon pricing system

- Reflect GHG emission reductions on incremental profits in investment economic evaluation
- Recognize GHG emissions as expenses in management accounting PL (internal carbon tax)

1

The new Social Value Contribution Award set up in fiscal 2022, an award presented by the President in recognition of business accomplishments

Background

In conjunction with the declaration in the Vision 2030 and Medium-term Direction 2024 that Murata's aim is to create a "continuous cycle of social and economic value," this new award was established to symbolize this aim and to accelerate activities to help reach that goal.

Scope

People or actions that have made outstanding contributions to the improvement of Murata's social value and the promotion of ESG activities

For example,

- Stakeholder-oriented initiatives aimed at increasing social value
- Contributions to solving of social issues through business
- Activities addressing social issues through Murata's business activities (such as materiality-related initiatives)

2

Initiatives at work sites that foster understanding and empathy to promote the creation of greater social value

All work sites are helping to create more social value, with the aim of fostering understanding and empathy among all employees on initiatives to address social issues so that they will see themselves as being directly involved.



<<Izumo Murata Manufacturing>>

Initiatives involving SDGs that help employees become more familiar with social issues and to see them as something that directly relates to themselves

<<ASEAN & India Sales>>

Initiatives that promote understanding and empathy by providing employees with an appreciation of the essence of the SDGs and having them think about how the SDGs are linked with Murata's business

<<The Philippines>>

Initiatives that promote understanding and empathy for addressing social issues based on employees' own experiences, such as support for the underprivileged

Information disclosure in recent years

- Improved communications of value creation stories through the *Murata Value Report (Integrated Report)*
- Disclosure of long-term and medium-term direction as well as capital allocation policy
- Review and revision of segment information disclosure classifications
- Improved sustainability information disclosure
- Enriched TCFD disclosure
- Improved content in securities reports and corporate governance reports
- Holding ESG briefings

External evaluations

IR activities

- 1st NIKKEI Integrated Report Award (2021)
Award for excellence



- IR Special Award (FY2022)



- Award for Excellence in Corporate Disclosure (FY2022)
Companies with significant improvement in disclosure

Sustainability

- Corporate Governance of the Year 2022
- Winner Company



- EcoVadis Gold Medal (FY2022)

- CDP
- CDP Climate A -
- Supplier Engagement Leader

Indexes

- Selected for all five GPIF indexes



FTSE Blossom
Japan



FTSE Blossom
Japan Sector
Relative Index



S&P/JPX
Carbon
Efficient
Index

2022 CONSTITUENT MSCI Japan
ESG Select Leaders Index

2022 CONSTITUENT MSCI Japan
Empowering Women Index (WIN)

- Selected by ESG indexes



FTSE4Good



2022 MSCI ESG Leaders
Indexes Constituent

Main initiatives of 2022

Key points

- Improved the Message from the President
- Clarified positions of Vision 2030 and Medium-term Direction 2024
- Reviewed Medium-term Direction 2021
- Shared examples of our continuous cycle of social and economic value
- Emphasized 3-layer portfolio and growth strategies for each product
- Improved the disclosure of human capital, *monozukuri* capital, and intellectual and technological capital
- Reviewed key issues (materiality) of previous medium-term period and announced new medium-term targets

Issues

- Communicating a more consistent value creation story led by our vision
- Increasing the determination from our growth strategies and emphasizing the strategy implementation strengths (capital) behind these strategies
- Providing explanations focused on the co-creation of value with stakeholders



Benefits of the *Integrated Report*

Integrated Report creation framework

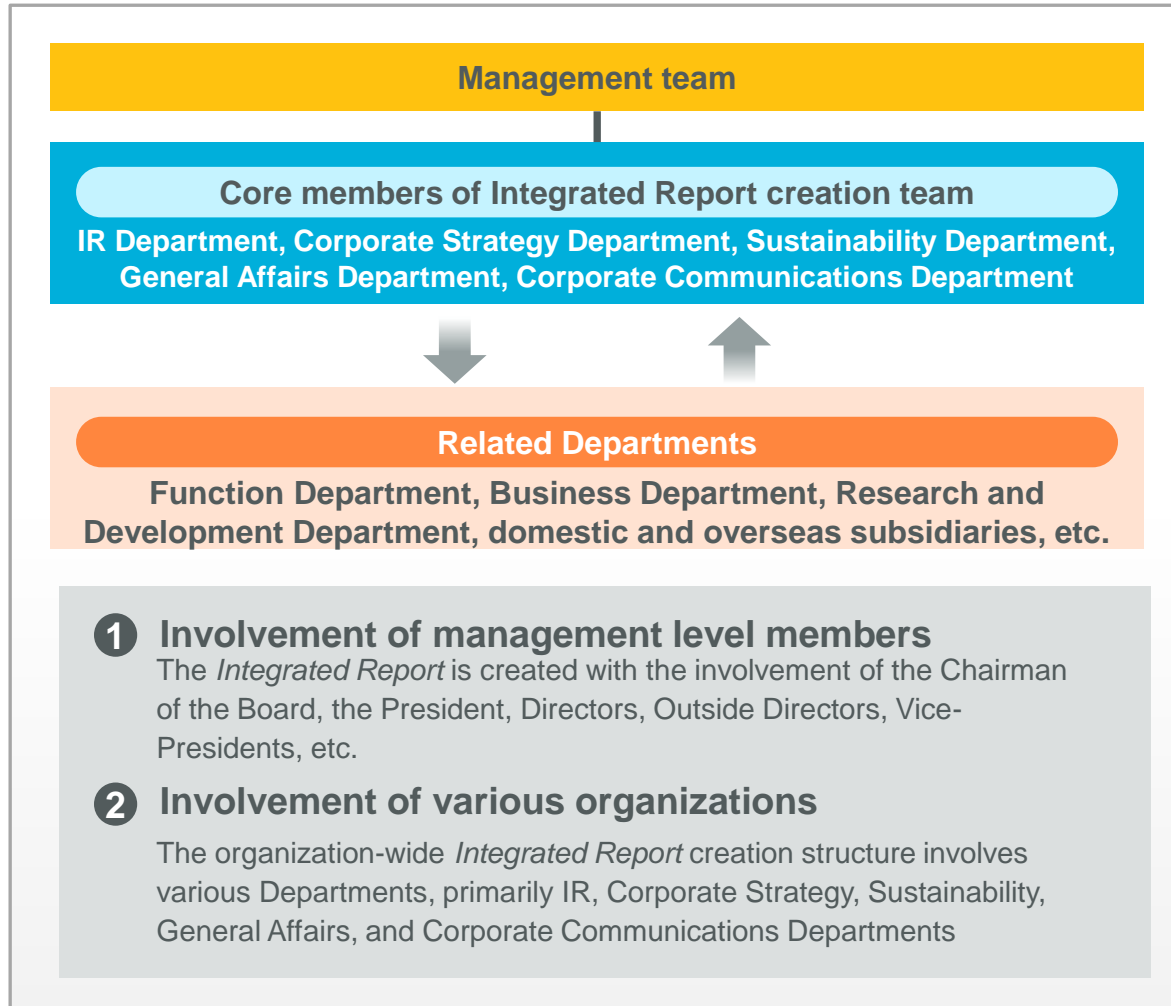

Expected benefits

Strengthened organizational capabilities

Strengthening integration between management and individual organizations will increase the resolution of Murata's value creation processes. The *Integrated Report* will enable each and every employee to get an overview of the entire company, contributing to the realization of autonomous and decentralized organizational management.

Enhanced corporate value through dialogue with stakeholders

The *Integrated Report* discloses information and promotes dialogue with stakeholders, driving a cycle of development and advancement that contributes to improved corporate value.

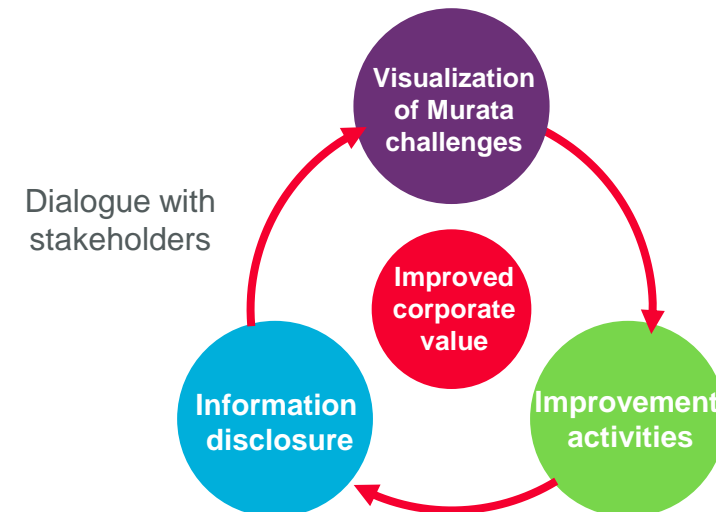

Cautionary Statement on Forward-looking Statements

This report contains forward-looking statements concerning Murata Manufacturing Co., Ltd. and its group companies' projections, plans, policies, strategies, schedules, and decisions.

These forward-looking statements are not historical facts; rather, they represent the assumptions of the Murata Group (the “Group”) based on information currently available and certain assumptions we deem as reasonable. Actual results may differ materially from expectations due to various risks and uncertainties. Readers are therefore requested not to rely on these forward-looking statements as the sole basis for evaluating the Group. The Company has no obligation to revise any of the forward-looking statements as a result of new information, future events or otherwise.

Risks and uncertainties that may affect actual results include, but are not limited to, the following:







1. Economic conditions of the Company's business environment, and trends, supply-demand balance, and price fluctuations in the markets for electronic devices and components
2. Price fluctuations and insufficient supply of raw materials
3. Exchange rate fluctuations
4. The Group's ability to provide a stable supply of new products that are compatible with the rapid technical innovation of the electronic components market and to continue to design and develop products and services that satisfy customers
5. Changes in the market value of the Group's financial assets
6. Drastic legal, political, and social changes in the Group's business environment
7. Other uncertainties and contingencies.

The Company undertakes no obligation to publicly update any forward-looking statements included in this report.



Appendix

Initiatives on Social Issues through Business Activities Overall 1

Set nine items of materiality in the fields of E (environmental), S (social), and G (governance)

Key areas	Key issues	Target
Environment    	Strengthening Murata's response to climate change	Fiscal 2024 targets: Amount of GHG emissions (Scope 1 + Scope 2): 20% reduction vs. fiscal 2019 Renewable energy implementation rate: 25% Fiscal 2030 targets: Amount of GHG emissions (Scope 1 + Scope 2): 46% reduction vs. fiscal 2019 Amount of GHG (Scope 3): 27.5% reduction vs. fiscal 2019 Renewable energy implementation rate: 50% Fiscal 2050 targets: Renewable energy implementation rate: 100%
	Use of sustainable resources	Fiscal 2024 targets: Rate of use of sustainable resources* ¹ : 1% improvement from fiscal 2021 results* ³ ; resource recycling rate* ² : 5% improvement from fiscal 2021 results* ³ Fiscal 2030 targets: Rate of use of sustainable resources: 25%; resource recycling rate: 50% Fiscal 2050 targets: Rate of use of sustainable resources: 100%; resource recycling rate: 100%
	Preventing pollution and managing chemical substances	Fiscal 2024 targets: Serious environmental incidents: 0; amount of VOC emissions: Equal to or lower than fiscal 2021 emissions Chemicals used for cleaning must not contain specific VOCs. Fiscal 2030 targets: Serious environmental incidents: 0; amount of VOC emissions: 30% reduction vs. fiscal 2021
Social   	Secure and safe workplace and health management	Fiscal 2024 targets: Fatal serious accidents: 0; accident rate per 1,000 workers: Less than 1.35 Fire accidents: 30% reduction compared with average for fiscal 2019-2021; subjective health view: 80% (with 14% reporting extremely good health) Fiscal 2030 targets: Workplaces must allow employees to work in a spirited manner, without any fatal serious accidents or employee injuries/accidents. Fatal serious accidents: 0; accident rate per 1,000 workers: Less than 1.0 Fire accidents: 0; subjective health view: 80% (with 20% reporting extremely good health)
	Respect for human rights and diversity	Fiscal 2024 targets: Percentage of overseas indirect employees* ⁴ with experience working at other sites: 7% Ratio of women in managerial positions: 4% (Murata Manufacturing Co., Ltd. on a non-consolidated basis) A PDCA cycle according to the Management System on Human Rights and Labor must be implemented at each worksite. Fiscal 2030 targets: Percentage of overseas indirect employees with experience working at other sites: 10% Ratio of women in managerial positions: 10% (Murata Manufacturing Co., Ltd. on a non-consolidated basis)
	Coexistence with local communities	Fiscal 2024 targets: Must continue to value communication with local residents and promote contribution activities with the goal of resolving local issues. Fiscal 2030 targets: Must continue to value communication with local residents and promote contribution activities with the goal of resolving local issues.

Initiatives on Social Issues through Business Activities Overall 2

Governance   	Appropriate business transactions	<p>Fiscal 2024 targets: Antimonopoly Act: Laws/ordinances and internal rules/procedures must be deployed and implemented globally. Bribery: In regions with a high corruption index, bribery management and prevention systems compliant with company policy must function and systems for reporting to headquarters must be established.</p> <p>Fiscal 2030 targets: Antimonopoly Act: Laws/ordinances and internal rules/procedures must be deployed and implemented globally. Bribery: All affiliated companies must establish bribery management and prevention systems compliant with company policy, and must maintain zero incidents of bribery/corruption.</p>
	Business continuity management (BCM)	<p>Fiscal 2024 targets: BCP that satisfies requirements must be established at domestic worksites and plants. BCP for handling disasters that might occur in our overseas locations must be formulated at each worksite and plant.</p> <p>Fiscal 2030 targets: A company-wide BCM must be established so that, if a disaster occurs, sites not affected by the disaster can cooperate quickly in order to maintain the business continuity of the entire Murata Group. Autonomous BCM activities must be performed, such as conducting periodic trainings at worksites and plants to verify and improve BCP effectiveness. Measures must be taken for a Nankai Trough earthquake, which is expected to cause major damage.</p>
	Information security	<p>Fiscal 2024 targets: Incidents determined to be potentially serious: 0; employee training ratio*⁵: 100%</p> <p>Fiscal 2030 targets: Incidents determined to be potentially serious: 0; employee training ratio: 100%</p>

*1 Resources at low risk of depletion, which Murata can use continually into the future by taking steps such as building recycling schemes.

*2 Percentage of Murata's outputs (emissions) that are recycled as circulating resources

*3 Actual figures for fiscal 2021 are currently being compiled.

*4 Applies to overseas local staff, excluding those transferred from Japan to overseas

*5 Ratio = (Number of sites that have conducted training) / (Total number of sites)