



---

Quarterly Financial Results Briefing  
3rd Quarter of FY2023

QD Laser, Inc.  
February 2024

## Mission

With the power of the semiconductor laser,  
“I can’t” becomes “I can”.

### Contents

01 Financial Results for FY2023-Q3

02 Semiconductor Laser Devices

03 Laser Retinal Projection

04 Business Growth

05 ESG Initiatives

What was once thought to be impossible is now a reality; we have become the only company in the world to successfully mass produce Quantum Dot LASERs.

Our laser technology will enable dramatic improvements in our ability to process information, support visually impaired people, prevent eye diseases, and enhance vision, continually pushing the boundaries of human possibility.

01

Financial Results for FY2023-Q3

## Financial Results Highlights for FY2023-Q3 vs FY2022-Q3

01 LD business sales **increased by 9%** YOY to 669 mil yen and LEW business sales **increased by 211%** YOY to 235 mil yen. Company-wide sales **increased by 32%** YOY to 904 million yen.

The LD business increased by 9% due to increases in DFB, high-power, and quantum-dot lasers, while the compact visible laser business decreased.

The LEW business increased significantly by 211% due to sales of RETISSA MEOCHECK, US sales of RETISSA NEOVIEWER, and the expansion of eye health check services.

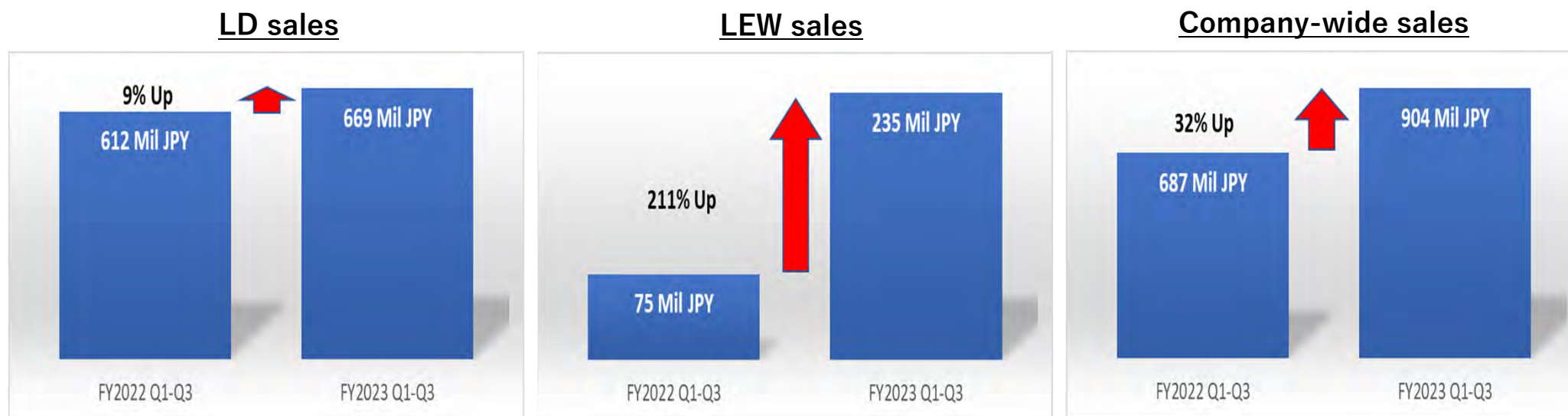

# Financial Results Highlights for FY2023-Q3 vs FY2022-Q3

## 02 LD business operating income **increased by 31% YOY to 51 mil yen**. Company-wide operating loss **improved by 68 mil yen (15%) YOY**.

Gross profit increased in the LD business due to increased sales, and operating profit increased 31% YOY to 51 million yen.

Gross profit also increased in the LEW business due to increased sales, so the operating loss improved compared to the same period last year.

Operating loss improved by 68 million yen from the same period of the previous year due to an increase in gross profit on a company-wide basis due to the rise in sales.

LD operating income

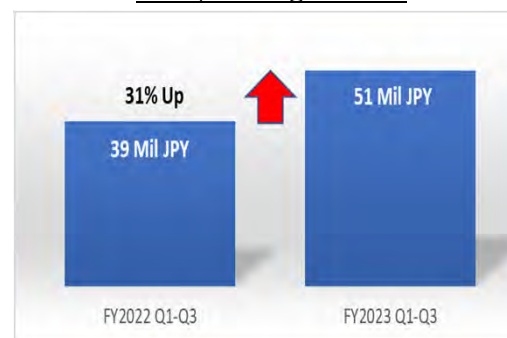

Company-wide operating loss

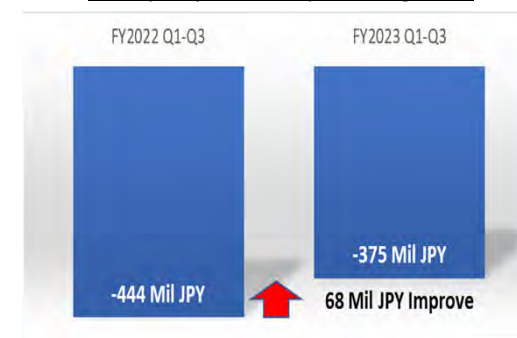

## 03 Ordinary loss **improved by 75 mil yen (17%) YOY**, and net loss **improved by 75 mil yen (17%) YOY**.

Ordinary loss improved by 75 million yen compared to the same period last year, which was larger than the improvement in operating loss, due to subsidy income.

Net loss also improved by 75 million yen, similar to the improvement in the ordinary loss.

Ordinary loss

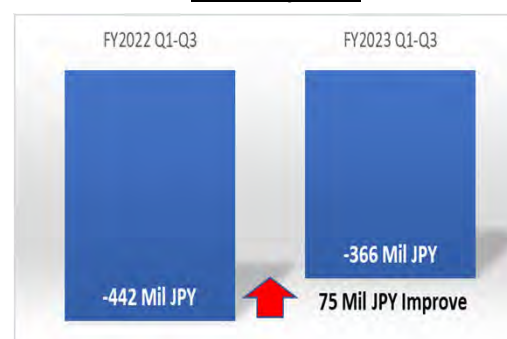

Net loss

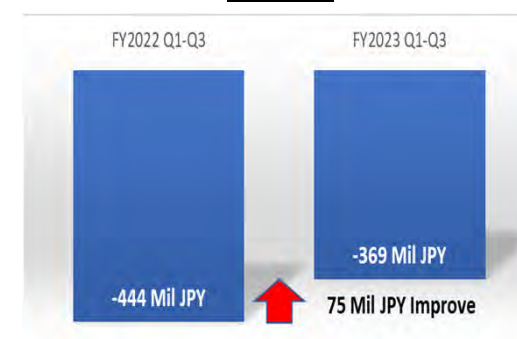

# Financial Results Highlights for FY2023-Q3 vs FY2022-Q3

## Increase in sales and decrease in losses compared with the same period of the previous year

Sales increased by 9% YOY for the LD business and by 211% YOY for the LEW business, resulting in a 32% YOY increase for the entire company. Operating income increased by 31% YOY to 51 million yen in the LD business, and the LEW business improved by 51 million yen YOY to -217 million yen. Operating loss improved by 68 million yen (15%) YOY to -375 million yen.

### Performance Summary

(Million JPY)	FY2023 Q1-Q3	FY2022 Q1-Q3	YOY
Sales	<b>904</b>	687	+ 32% (+ 216)
(LD)	<b>669</b>	612	+9%
(LEW)	<b>235</b>	75	+211%
Operating Profit or Loss (△)	<b>△375</b>	△444	+68
(LD)	<b>51</b>	39	+12
(LEW)	<b>△217</b>	△268	+51
Ordinary Loss (△)	<b>△366</b>	△442	+75
Quarterly Net Loss (△)	<b>△369</b>	△444	+75



### Sales by Product Group

(Million JPY)	FY2023 Q1-Q3	FY2022 Q1-Q3	YOY
DFB Laser	<b>279</b>	222	+25%
Compact Visible Laser	<b>135</b>	166	△19%
High-Power Laser	<b>170</b>	155	+10%
Quantum Dot Laser	<b>84</b>	67	+25%
<b>LD Total</b>	<b>669</b>	<b>612</b>	<b>+9%</b>
<b>LEW Total</b>	<b>235</b>	<b>75</b>	<b>+211%</b>
<b>Grand Total</b>	<b>904</b>	<b>687</b>	<b>+32%</b>

## Balance Sheet

Total assets increased by 1,371 million yen due to increased cash and deposits, etc. Total liabilities decreased by 113 million yen due to a decrease in A/P and the equity ratio was 94.1%<sup>\*1</sup>(90.1%<sup>\*2</sup> at the end of the previous fiscal year).

### Balance Sheet

(Million JPY)	End of December 2023	End of March 2023	YOY
Current Assets	5,929	4,617	+ 1,311
Fixed Assets	360	300	+ 59
<b>Total of Assets</b>	<b>6,289</b>	<b>4,918</b>	<b>+ 1,371</b>
Current Liabilities	328	436	△107
Fixed Liabilities	36	42	△6
<b>Total of Liabilities</b>	<b>364</b>	<b>478</b>	<b>△113</b>
<b>Net Assets</b>	<b>5,924</b>	<b>4,439</b>	<b>+ 1,484</b>
<b>Total Liabilities and Net Assets</b>	<b>6,289</b>	<b>4,918</b>	<b>+ 1,371</b>

# DFB Lasers for Precision Machining and Measurement : Sales in FY2023-Q3<sup>\*1</sup>

**279 million JPY sales, increased by 25% YOY.**

- **Measurement(semiconductor wafer inspection): 25%**
  - Europe: Sales of light sources for inspection equipment in the semiconductor wafer process increased by 68% YOY.
- **Micromachining: 31%**
  - North America: Postponed due to overstock of lasers for processing equipment by 67% YOY.
  - China: Sales of 39,747K yen due to new orders for lasers for processing equipment
- **Measurement(Sensor system): 22%**
  - Europe: Sales decreased by 18% YOY due to decrease of demands from China although orders for LiDAR light sources are strong.
  - Japan: Sales of measurement light sources increased by 369% YOY.
  - North America: Sales of 8,293K yen due to orders for light sources for sensors.
- **Medical equipment: 21%**
  - Japan: Sales of light sources for ophthalmic diagnosis increased by 68% YOY.
  - Europe: Sales of light sources for medical inspection increased by 93% YOY.

Sales of Q3 in FY2021, 2022 and 2023

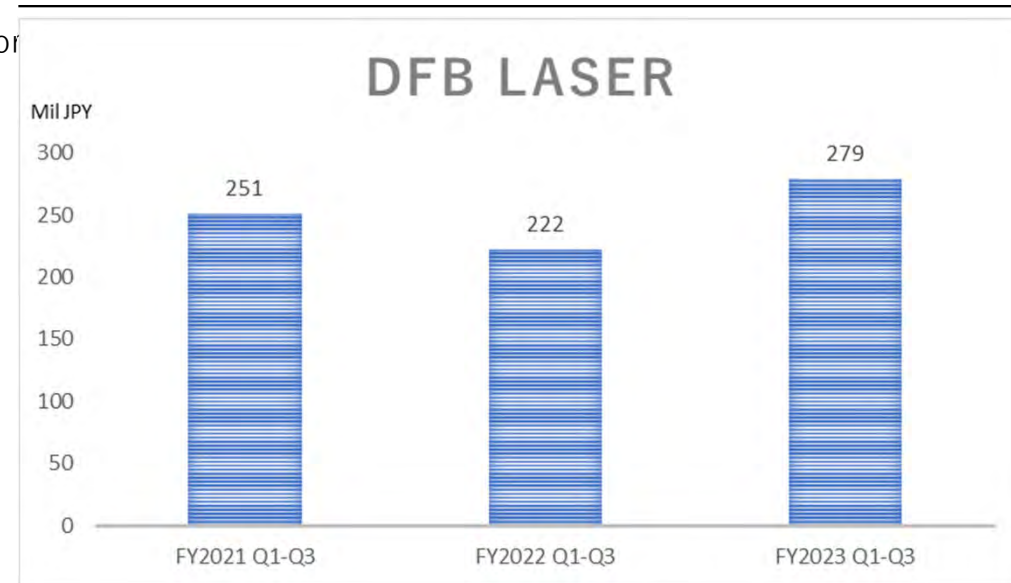

DFB lasers  
 Left : for 15 ps pulsed operation  
 Right : for 50 ps pulsed,  
 ns pulsed, and CW operations

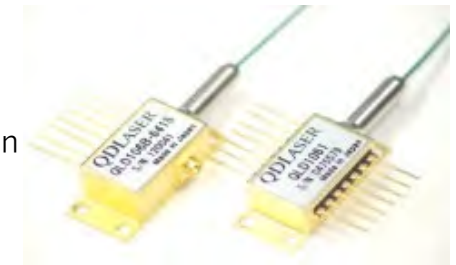



# Compact Visible Lasers : Sales in FY2023-Q3

**135 million JPY sales, decreased by 19% YOY.**

- **Blood/cell analysis(Flow cytometer/cell sorter\*1): 49%**

- China: Demand for bio-testing equipment declined due to the end of COVID-19 countermeasures. Due to changes in customer production plans and inventory adjustments associated with this, sales decreased by 61% YOY.

- North America: Sales of light sources for biomedical equipment increased by 203% YOY.

- **Microscope: 49%**

- Europe: Sales increased by 445% YOY due to orders from a biomedical STED\*2 microscope manufacturer in mass production.

- Europe: Sales increased by 379% YOY with the start of mass production for biomedical applications.

- Japan: Sales increased by 145% YOY with the start of mass production for biomedical applications.

Sales of Q3 in FY2021, 2022 and 2023

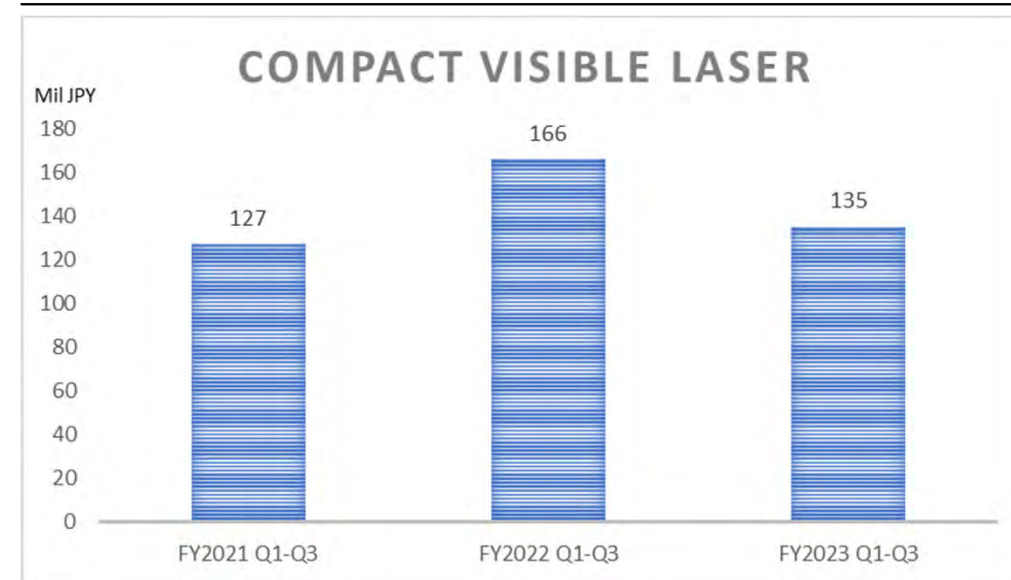

Compact visible lasers  
Left: green,  
Middle: yellow-green, and  
Right: orange.



# High-Power Lasers : Sales in FY2023-Q3

**170 million JPY sales, increased by 10% YOY.**

- **Leveler for construction/DIY and sensor: 47%**

- China: A light source for sensors and levelers. Sales increased by 3% YOY, despite the impact of the suspension of factory operations due to COVID-19 in the previous fiscal year.

- North America: Sales of light sources for sensors increased by 375% YOY.

- Japan: Sales of light sources for sensors increased by 146% YOY.

- **Sensor in semiconductor factories: 25%**

- Japan: Sales of light sources for sensors of wafer transfer machines to be used in semiconductor factories for 2 companies increased by 72% YOY.

- North America: Sales of light sources for particle counters in semiconductor factories increased by 38% YOY.

- **Machine vision and data communication in factories: 26%**

- North America: Sales of light sources for data communication in factories increased by 293% YOY.

Sales of Q3 in FY2021, 2022 and 2023

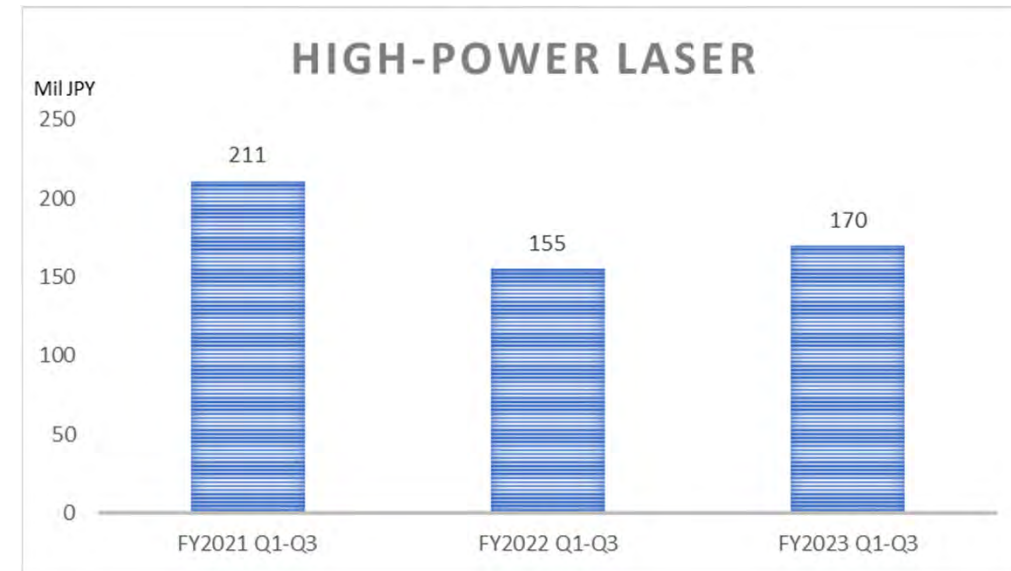

High-power lasers  
TO package

# Quantum Dot Lasers<sup>\*1</sup> : Sales in FY2023-Q3

**84 million JPY sales, increased by 25% YOY.**

Working on quantum-dot lasers for silicon photonics with nine customers in Japan, the US, and Europe.

- Japan: Shipped chips for optical connector and chip-to-chip communication. Continuing cost-reduction activities. Mass production started in 2023, and 60,000 units were ordered from 2023 to 2024. 24,000 units were shipped.
- North America: Shipment of wafers for optical connector and chip-to-chip communication.
- North America: Wafers were shipped after receiving repeat orders from the customer of the optical connector and chip-to-chip communication.
- Four universities and research institutes in Japan, North America and Europe: Inquiries about quantum dot wafers for research. Wafers were shipped after receiving the PO.

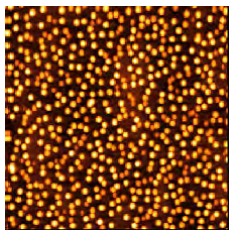

Quantum dot



Quantum dot wafer

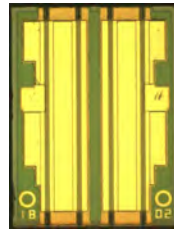

Quantum dot laser chip

Sales of Q3 in FY2021, 2022 and 2023

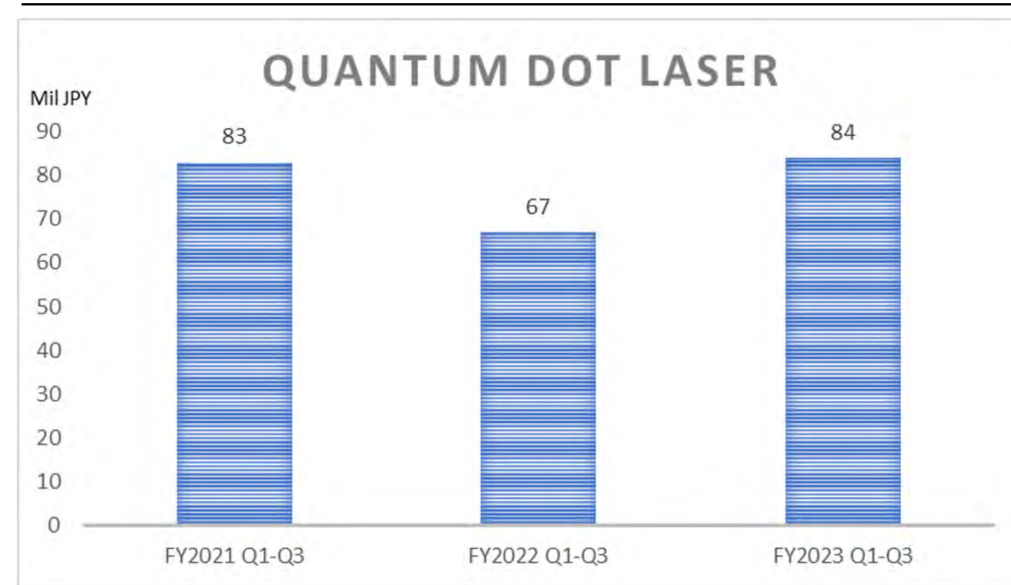

# Laser Eyewear (LEW) : Sales in FY2023-Q3

**235 million JPY sales, increased by 211% YOY.**



Sales of Q3 in FY2021, 2022 and 2023

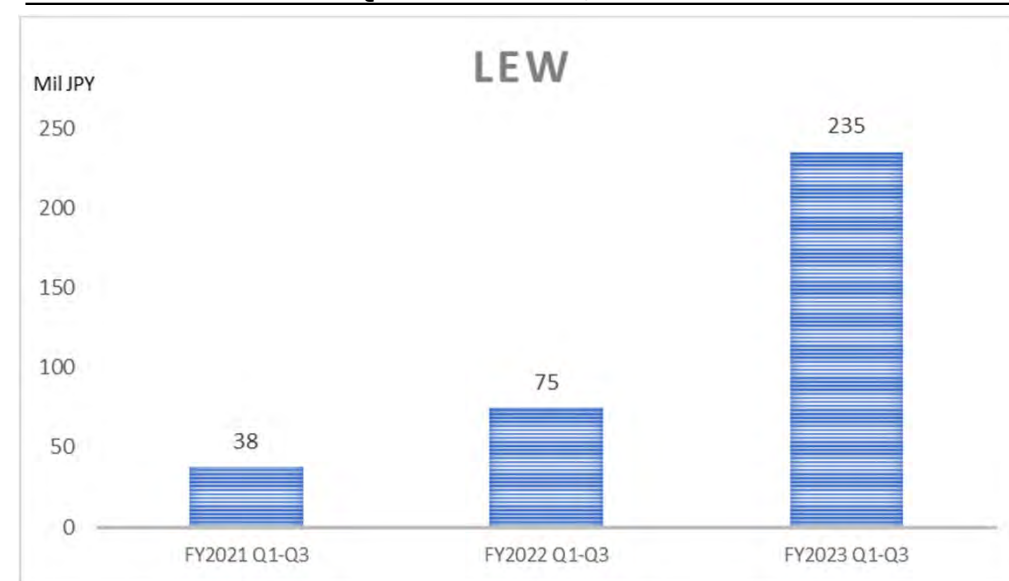

## ■ Three new products "MEOCHECK," "NEOVIEWER," and "ON HAND."

- RETISSA MEOCHECK (Released on February 1<sup>st</sup>, 2023)
  - Shipped 600 units to a sole agent
  - "Vision Health Check Service" to Nihon Kotsu Co., Ltd. continues this Autumn
- RETISSA NEOVIEWER (Released on March 24<sup>th</sup>, 2023)
  - Released as a bundle "DSC-HX99 RNV kit" with a Sony digital camera
  - Available at five Sony stores nationwide and in the US
  - Increased touch and try opportunities through rental program
- RETISSA ONHAND (Released on March 25<sup>th</sup>, 2023)
  - Sales through domestic sole agents in the field of government and welfare
  - Gradual introduction in public facilities such as libraries and museums

## ■ RETISSA Display II+RD2CAM

- Sold through distributors such as SEED and various EC channels
- Gradual expansion of certification and informal offers on subsidies for daily life tools - approved in 15 cities, accredited in 5 cities.

## ■ Commissioned development

- Undergoing elemental technology development for next-generation retinal laser imaging eyewear (smart glass ,i.e., Display 3) under collaboration with TDK, NTT Laboratories, mobile device manufacturers, etc.
- Development of fundus imaging camera (SLO) for medical device application under the partnership with University Tohoku COI-NEXT.

# Revision of Annual Forecast

Annual forecast is revised on February 14, 2024.

## Revision of Annual Forecast

	Sales	Operating Loss	Ordinary Loss	Net Loss	Net Loss per Share
	Mil JPY	Mil JPY	Mil JPY	Mil JPY	JPY
Previous announcement forecast (A) <sup>*1</sup>	1,446	-559	-577	-582	-15.11
(LD)	1,014	67			
(LEW)	432	-296			
Revised forecast (B)	1,244	-559	-577	-582	-13.98
(LD)	930	67			
(LEW)	314	-305			
Increase / decrease amount (B-A)	-202	—	—	—	
(LD)	-84	-			
(LEW)	-118	-8			
Increase / decrease ratio (%)	-14.0	—	—	—	
(LD)	-8.3	-			
(LEW)	-27.3	-2.9			
Previous year result	1,159	-556	-546	-550	-15.16
(LD)	891	64			
(LEW)	268	-338			

In the LD business, demand for bio-testing equipment declined due to the end of COVID-19 countermeasures in China. As a result, our customers' production plans have changed, and inventory adjustments have been made. As a result, demand for compact visible lasers has declined. Although efforts were made to compensate for this by increasing sales of DFB lasers, etc., this was not enough to compensate for the overall decline in demand. In the LEW business, in response to sluggish sales of RETISSA ON HAND to individuals in Japan, we have reviewed our target market and are promoting sales to cultural facilities and overseas. Regarding the latter, we are continuing to negotiate with overseas companies and have not yet concluded a contract.

We have determined that we cannot expect to make up for the decrease in demand for small visible lasers or conclude a contract or receive an order for RETISSA ON HAND during the current fiscal year, so we have revised our business forecasts.

Although sales decreased by 202 million yen, profits are expected to be in line with initial forecasts as SG&A are expected to decrease.

## Revision of Annual Forecast - Growth Strategy of Compact Visible Laser -

Despite a temporary slowdown due to changes in production plans and inventory adjustments by a significant customer, the number of customer companies and installed equipment steadily increased, and solution products “Box module” were demonstrated, making progress toward expanding market share.

- Current product sales volume and market share

※less than1%

Wavelength (nm)	Color	FY2022 Sales in units	FY2023 Planned Sales in units	FY2023 Q1-Q3 sales in units	Number of customers FY2022→FY2023Q1-Q3	Estimated market share
532	green	24	24	24	2 → 3	※
561	Yellow green	1,438	1,697	646	6 → 12	36%
594	Orange	10	10	1	1 → 1	※
Total		1,472	1,731	681	8 → 13	18%

- Aiming for annual growth of 30% from FY2023 ⇒ 3 measures ⇒ Market share 44% @ FY2027\*

1. Promotion

- Increase in client companies: 8 in FY22 ⇒ 13 companies
- Increase of installed equipment: 9 in FY22 ⇒ 19 models

2. New laser development

- New wavelengths (488nm, 552nm): Market of 11,500 units
- High output power(30 ⇒ 50mW): Market of 3,800 units

3. Solution

- Box module : Market of 10,600 units  
Demonstrated in Photonics West 2024 in January



- Multicolor sources : Market of 12,500 units

# Revision of Annual Forecast - Steps Towards the Proliferation of Low Vision Aid "RETISSA ON HAND" -

We are creating values to enjoy "real content" at cultural facilities, aiming for an inclusive society via the low-vision participation in cultural and artistic activities.

## FY2023

Value clarification, implementation records

- Experience events (15 times)
- Beginning of trial introduction (19 units) at venues such as the Museum of Contemporary Art Tokyo
- Work with Tohoku University COI-NEXT to realize a society connected by "seeing" based in Miyagi Prefecture

ON HAND  
Initial model



Experience events



## FY2024

Information dissemination, cultural business development, and implementation expansion

- Launching a dedicated web page including challenges to realizing an inclusive society, testimonials, facility introduction process and examples
- Economic support through foundations and donations
- Establishment of cultural business

ON HAND initial model overseas sales start.  
ON HAND Global Model development and commercialization.

## FY2025~

Domestic and international spread and contribution to GDW<sup>\*1</sup>

- In Japan: 5,738 venues
  - Worldwide: >100,000
- Including art museums, museums, zoos, aquariums, libraries, theaters, stadiums, travel, and tourist facilities.

Global sales network

# Sales & Order Status

As of the end of the 3rd quarter, sales + order backlog (scheduled sales within the fiscal year) accounted for 87% of the annual sales forecast, 1,088 million yen, the highest in the last 3 years.

**Net sales for FY2023-Q3 and order backlog as of the end of the FY2023-Q3**

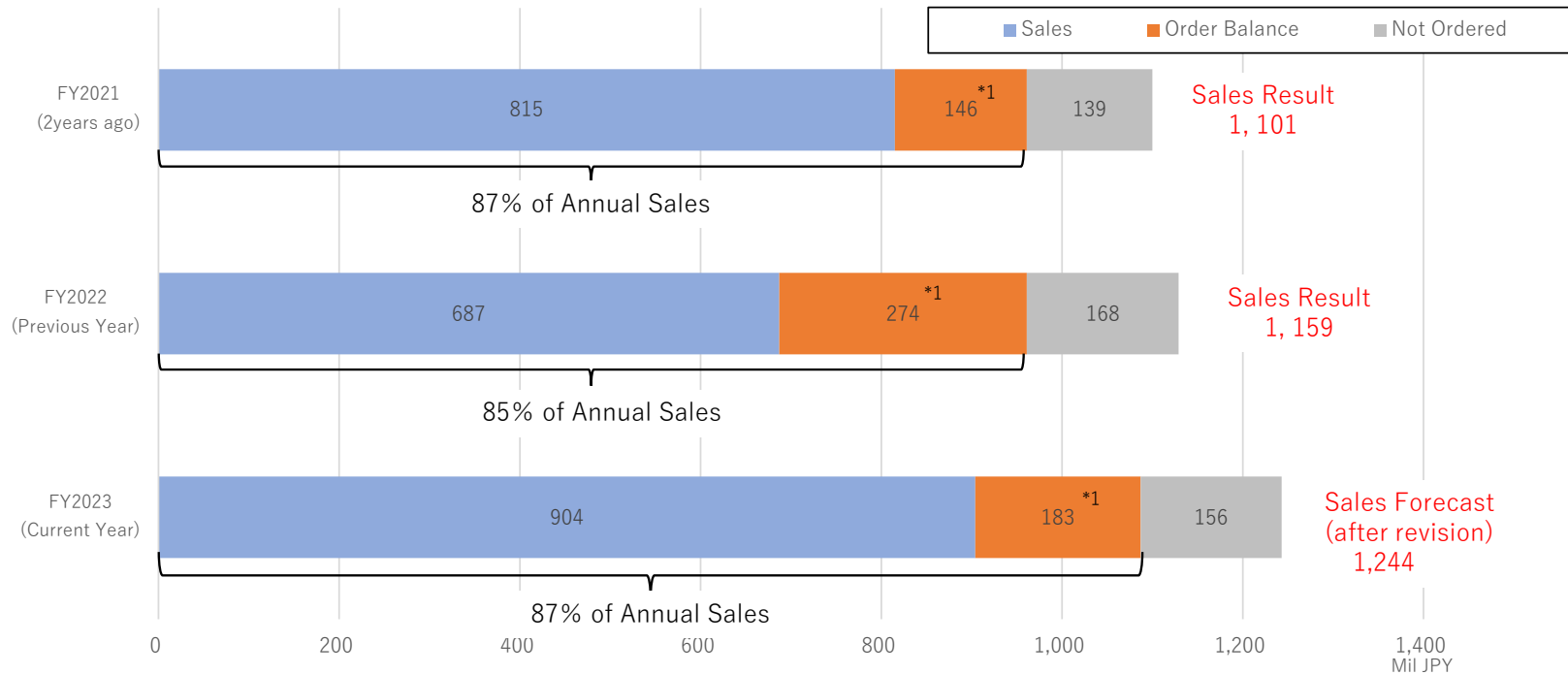



# 02

## Business Growth

Fiscal year ending March 2023, fiscal year ending March 24, medium-term, and medium- to long-term

# Business Highlights for FY2022

Significant progress in both businesses toward company-wide operating profit shortly and subsequent explosive growth

## Laser Device (LD) Business

Operating profit  
consecutive **8** years

Operating profit of  
64 million yen (+5% YoY)

Certified customers

**68** institutions

Contributions of compact visible lasers for biosensing, DFB lasers for wafer sensing, and high-power lasers for sensing in semiconductor factories

QD lasers for silicon optical wiring.  
Mass production order of

**12,000** units

Cumulative orders of more than 60,000 units received this April 2023<sup>\*1</sup>. QDLaser is starting to build a full-scale mass production system

## Laser Eyewear (LEW) Business

YoY sales

**183%**UP

Sales of 268 million yen (12% higher than forecast<sup>\*2</sup>). Contributions from new product launches and commissioned developments.

New retinal projection devices

**3 Models** released

Bundle sales in collaboration with Sony.<sup>\*3</sup>  
Strengthened sales by cooperating with domestic agencies.

Vision Health Check Service

**Service started**<sup>\*4</sup>

From trial to the full-scale introduction in a major taxi operator

\*1 : Published on April 17, 2023 "Received orders of 60,000-unit quantum dot lasers"

\*2 : Published on February 14, 2023 "Quarterly Financial Results Briefing 3rd Quarter of FY2022" Page 13

\*3 : Refer to "Announcement regarding the conclusion of a collaborative agreement with Sony Corporation on the sale of retinal projection equipment," announced on February 21, 2023.

\*4: Announced on November 15, 2022, "We have developed a new device called "MEOCHECK" that allows you to self-check your eye health in 2 minutes. Implementation of a trial to introduce it to the regular health checkup of Nihon Kotsu taxi drivers."

# Major Business Target for FY2023

Updating business for early company-wide operating profit and subsequent explosive growth

## Laser Device (LD) Business

<p>Operating profit</p> <p>Consecutive <b>9</b> years</p> <p>Operating profit of 67 million yen. Net sales 1.01 billion yen. (up 14% year-on-year)</p>	<p>New LD product development</p> <p><b>7</b> products</p> <p>High-speed DFB laser for processing and measurement, new wavelength/module of compact visible laser, and quantum dot DFB laser</p>	<p>QD lasers for silicon optical wiring. Starting mass production of</p> <p>&gt; <b>60,000</b> units</p> <p>Mass production starting in May. Constructing mass production system for 1 million units/year.</p>
--	--	--

## Laser Eyewear (LEW) Business

<p>YoY sales</p> <p><b>61%UP</b></p> <p>Sales of 432 million yen. Expansion of sales of new products, progress in commissioned development of smart glasses</p>	<p>New retinal projection devices</p> <p><b>Overseas</b> expansion</p> <p>RNV sold by Sony in the United States. Preparation for sales of ON HAND in the U.S. and China, and low-cost production.</p>	<p>Vision Health Check Service</p> <p><b>Service</b> expansion</p> <p>Full-scale introduction by major taxi operators, cross-industry expansion and the implementation of subscription model.</p>
---	---	---

## Mid-term business target (about 3 years)

Achieve company-wide turn around and establish the foundation for explosive growth thereafter

### Laser Device (LD) Business

<p>Operating profit</p> <p>Consecutive <b>10-11</b> years</p> <p>Launch of global niche products and the transition from joint research to mass production for silicon photonics products</p> <p>Operating Profit &gt;300 million yen (Gross margin &gt;40%)</p>	<p>New products for global niche</p> <p>Net sales &gt;<b>400mil.</b> yen</p> <p>Contribution of new products scheduled in 2023</p> <ul style="list-style-type: none"> <li>• Value added visible laser modules</li> <li>• DFB laser for semiconductor wafer/mask inspection</li> <li>• DFB laser for fast and precise machining</li> </ul>	<p>QD lasers for silicon optical wiring mass production order</p> <p>60k units → <sup>*1</sup> <b>200~400k</b> units</p> <p>Increased market for silicon photonics by joint research partner's mass production, a milestone for the introduction of 3<sup>rd</sup> MBE to expand mass production capacity</p>
--	---	---

### Laser Eyewear (LEW) Business

<p>Net sales</p> <p>260mil.<sup>*2</sup> → &gt;<b>1bil.</b> yen</p> <p>Contribution of 3 new RETISSA and vision health check service by expanding sales partnership</p> <p>Three new RETISSA &gt;800mil. yen total Vision health check service &gt;200mil. yen</p>	<p>Three new RETISSA</p> <p>500units<sup>*2</sup> → <b>5,000</b> units</p> <p>Establishment of sales capability in JP/US/EU/CN with partners including Sony during FY2023-2024. Compliance to safety regulation in each region. Establishment of global mass production capability.</p>	<p>Vision health check service</p> <p>4,000 users<sup>*1</sup> → <b>70,000</b> users</p> <p>Expansion by penetration to health check in transportation industry such as taxi and freight. Nationwide expansion of drugstore franchise. Launch of data service to administrator/individual viewer.</p>
--	---	---

# Expected growth potential in mid to long term

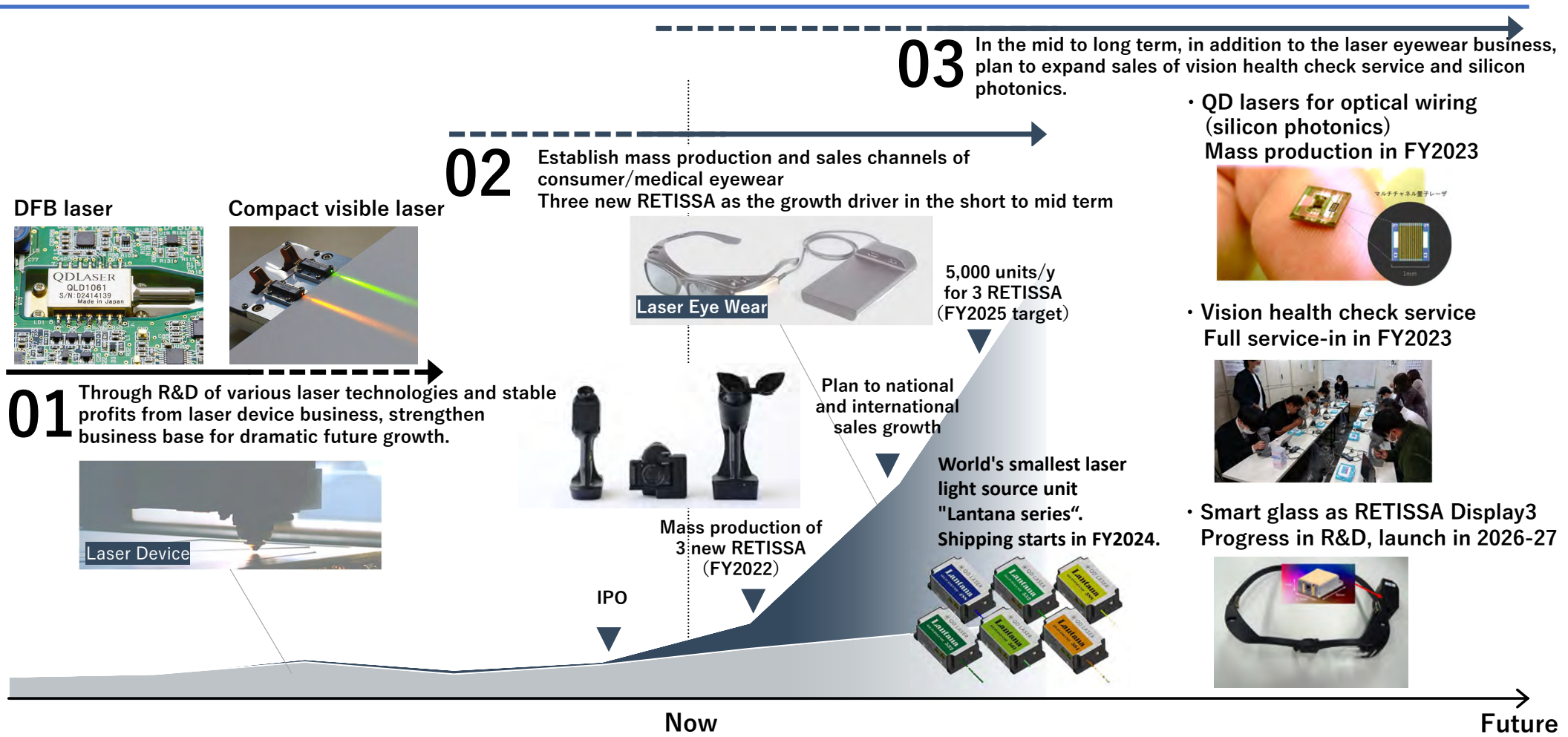

# Laser Device Business Strategy

Based on the technology and products that have established our position in the industry, we will 1) expand across customers and develop new applications, 2) expand globally, and 3) develop module & solutions to realize significant growth.

							Estimated market size of the final product*1	Estimated market size of QDL products
<b>DFB</b> · World's fastest speed of 15ps · High-speed electronic circuit	Measurement	Wafer test	Mask test	Topographic survey	Brain monitor	Axial length	1,480 billion-yen@2032 CAGR 10%*2	14.8 billion-yen
	Micro machining	Electronic circuits	Composite materials	Emerging countries for nano and pico-second machining			652 billion-yen@2027 CAGR 7.3%*3	6.5 billion-yen
<b>Compact Visible</b> · World's smallest size · World's minimum power consumption · World's fastest 50ps	Bio-analysis	Flow Cytometer	Cell sorter	Total solution with 1)All wavelength (405nm~635nm) 2)World's smallest modules			1,129 billion-yen@2030 CAGR 7.2%*4	11.3 billion-yen
	Microscope	Confocal microscope	STED microscope				990 billion-yen@2030 CAGR 9.0%*5	9.9 billion-yen
<b>High Power</b> · World's highest nanosecond peak power · High reliability	Leveler	Construction site	Manufacturing plant	DIY	Measurement	555 billion-yen@2032 CAGR 4.3%*6	5.6 billion-yen	
	Sensors	Wafer transport	Spatial communication	Machine vision	Particle counter	233 billion-yen@2030 CAGR 10.1%*7	2.3 billion-yen	
<b>Quantum dots</b> · High temperature stable operation · High reliability · Low noise	Optical wiring	Super computer	Medical · FA	5G/6G	Self-driving	1,219 billion-yen @2030 CAGR 25.8%*8	12.2 billion-yen	
	LiDAR	Drone	Self-driving	Robotics				
						<b>Total 6 trillion-yen</b>	<b>Total 63 billion-yen</b>	

\*1 : Please note that it is indicative of the overall size of our potential target market and is not a predictor of our performance. Calculated at the exchange rate of JPY/USD=150 yen/dollar.  
 \*2 : Future Market Insights [Wafer Inspection Market by Technology, Defect Type & Region - Forecast 2022 - 2032]  
 \*3 : Grand View Research [Micromachining Market Size & Share Report, 2020-2027]  
 \*4 : Grand View Research [Global Flow Cytometry Market Size Analysis Report, 2030]

\*5 : Grand View Research [Super-resolution Microscopes Market Size Report, 2022-2030]  
 \*6 : Global Market Insights [Construction Laser Market]  
 \*7 : Marketysers Global Consulting [Laser Sensor Market]  
 \*8 : Grand View Research [Silicon Photonics Market Size, Share & Trends Analysis Report]

# Laser Eyewear(Visual Information device) Business Strategy

We aim for significant growth by investing in technology development, product development, and business development, while expanding sales and increase our access to potential markets.

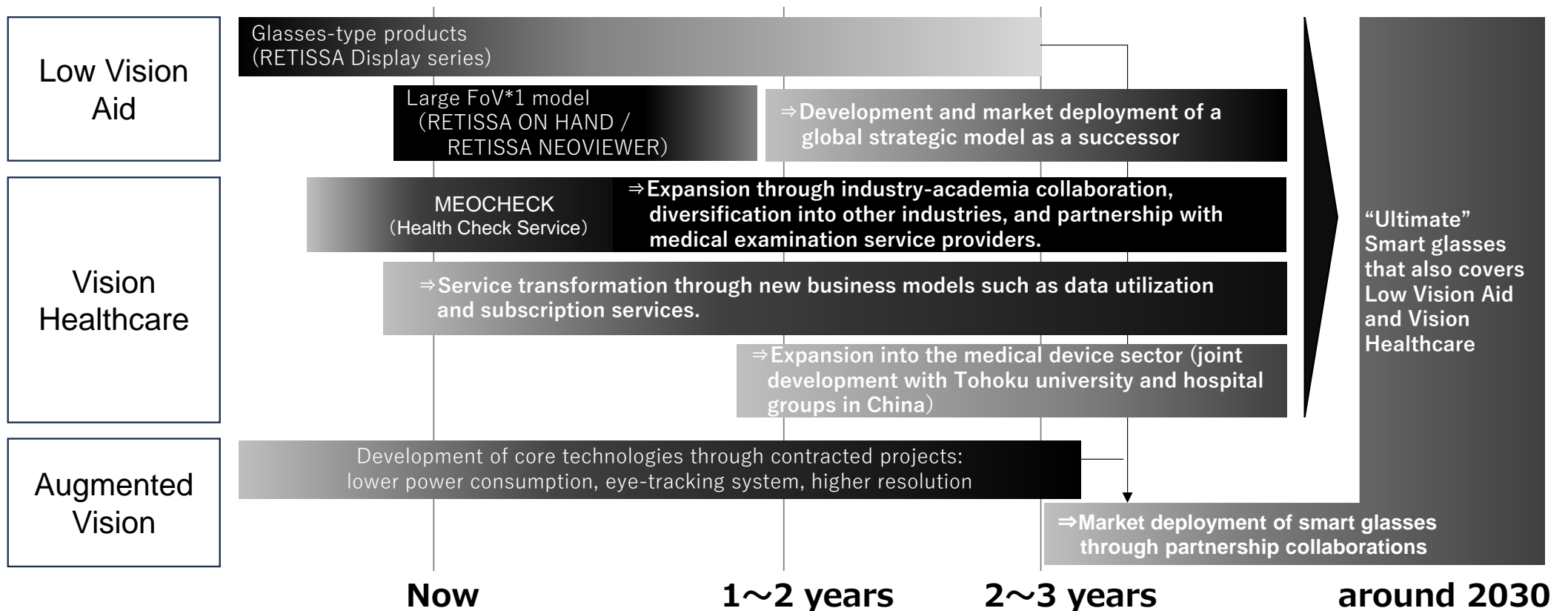

# 03

## Semiconductor Laser Devices

Solid Earnings Base and High Growth Potential  
under Global Laser Market Expansion



# What is a Semiconductor Laser?

A tiny device to provide laser light by injecting an electric current through a semiconductor.

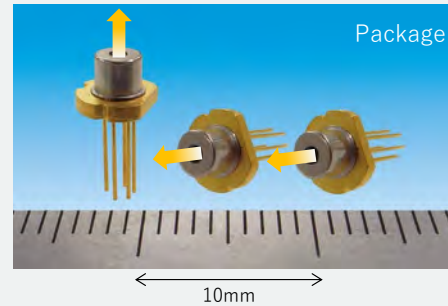
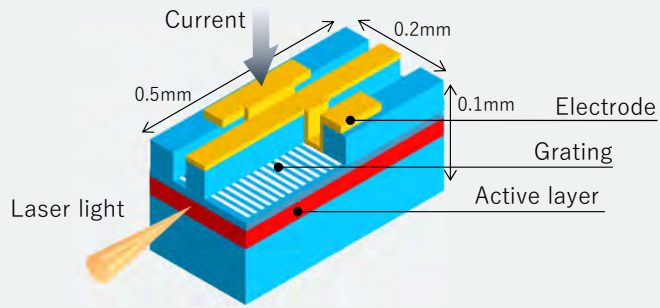

First Large-Scale Applications of Semiconductor Lasers: Optical communication and optical recording have significantly contributed to the global information and communication infrastructure.

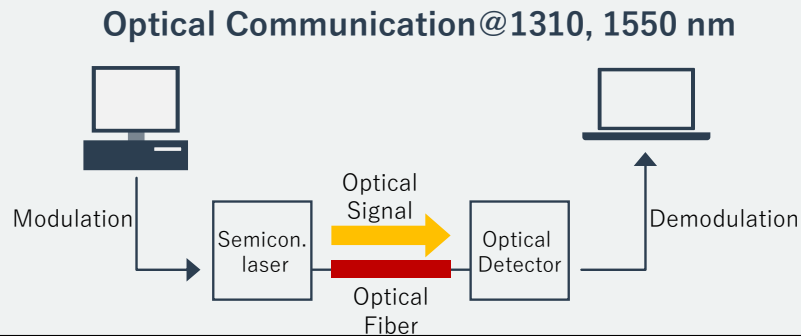

Optical Recording@660nm, 450nm

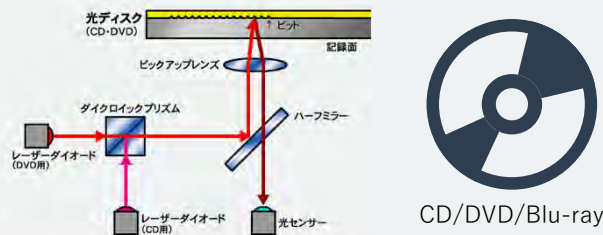

# Expected Role of QD Laser, Inc.

## Semiconductor Laser History and Our Position in the 3<sup>rd</sup> Phase

### 1<sup>st</sup> phase

#### Proposals of Scientific Principles and Invention of Laser (1960s)

##### Laser

A technology used in recording, communication, processing and sensing.

Applied in various industries such as medicine, home appliances, automobiles, manufacturing and entertainment.

### 2<sup>nd</sup> phase

#### Invention of Semiconductor Lasers, Building out Optical Communication and the Internet (1995~)

##### Semiconductor lasers and packaging



##### Semiconductor laser:

A small element with a length of about 1 mm that causes a laser to oscillate by passing a current through a semiconductor. Compared with other lasers, possesses excellent properties such as ultra-small size, high-speed modulation characteristics reaching several 10s of GHz, high power-to-light conversion efficiency (in several 10s of %), and wavelength controllability, etc.

### 3<sup>rd</sup> phase

#### Accelerating the Integration of Humans and Information (2020s~)

Fields where our lasers are applied (being Developed or Commercialized)

- 5G base station
- Supercomputer
- Visual Aid
- Smart Glass
- Optical Interconnect
- Facial recognition
- Fundus photography
- Micromachining
- In-Vehicle communication
- LiDAR for autonomous cars
- Biophotonics
- Visual field testing

### Nanotechnology of QD laser to generate and control laser light

Image of quantum dots taken by an atomic force microscope and a quantum dot laser equipped on fingertip-sized silicon chip as 100Gbps optical transceiver

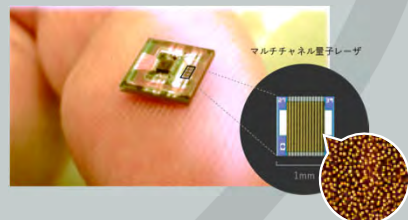

##### Quantum Dot Laser:

A semiconductor laser adopting a quantum dot structure which has a semiconductor nano-sized microcrystal in its active layer. Compared with existing semiconductor lasers, these lasers are superior in temperature stability, temperature resistance, and low noise.

# New Era for Semiconductor Lasers

We are developing products for all applications shown below and have launched a part of them.

- **Optical interconnect** ⇒ enhancing the computing and data processing power

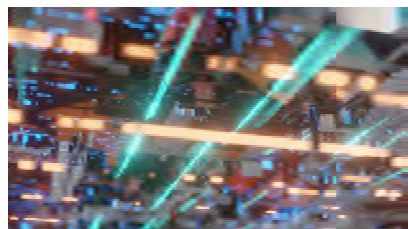

- **Sensor** ⇒ Precise detection of human and material (shape, position, velocity)

Biomedical

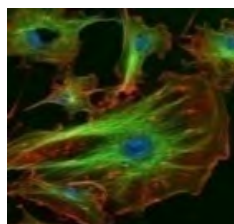

Face recognition



LiDAR (Automotive, Robotics, Drone)



Motion recognition



Fundus, Sight, Field of view

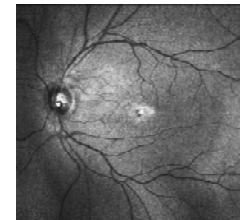

- **Micromachining** ⇒ Highly functional/high precision device manufacturing



- **Display** ⇒ AR/VR/XR

Smart Glasses



Head-up display





Features of semiconductor lasers developed and offered by QD Laser

01

## Flexible arrangement

Providing semiconductor lasers with any wavelengths suitable for applications

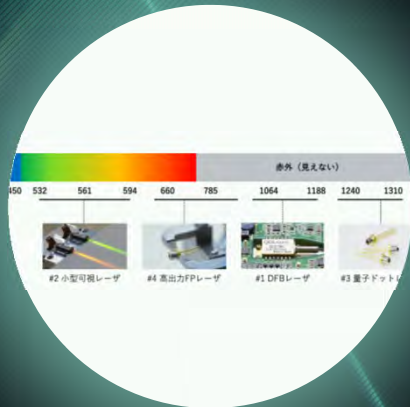

02

## Stable short pulse

Leading to precision in various applications due to low noise in time and spectrum

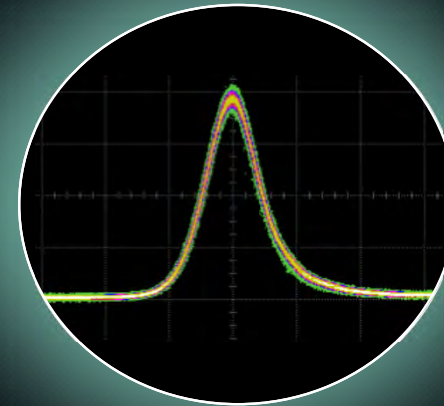

Unique manufacturing process by QD Laser

# The only semi-fabless system in semiconductor laser industry

”Horizontal specialization” powered by our core competency of epitaxial growth technology

- Flexible manufacturing scale of several units to tens of millions units
- Converting fixed costs into variable costs
- Mass production and diverse product offering lead to beyond breakeven point



Product design  
Quality control

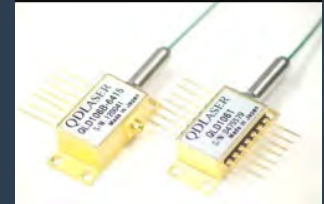
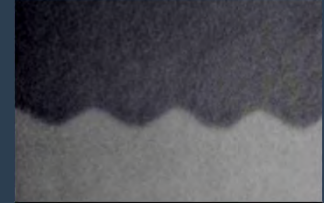
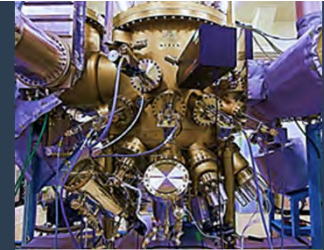
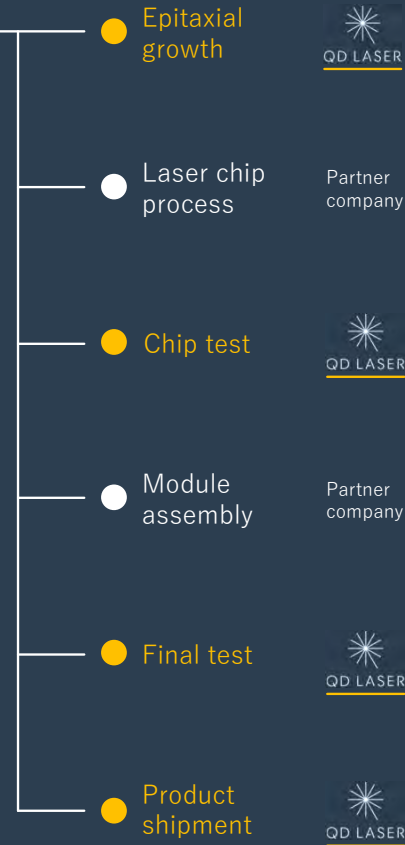

# Variations on semiconductor lasers developed and sold by QD Laser

QD Laser provides a wide range of semiconductor lasers with wavelengths suitable for each application

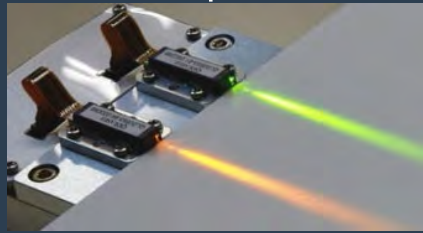
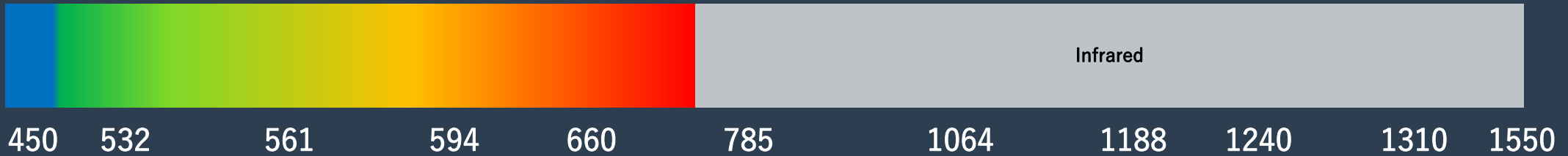

#2 Compact Visible Laser

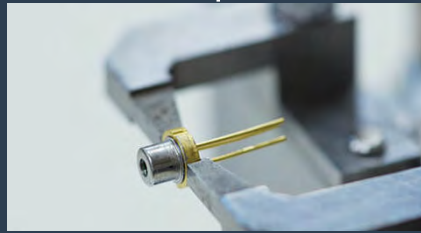

#4 High Power Laser



#1 DFB Laser



#3 Quantum Dot Laser

# #1

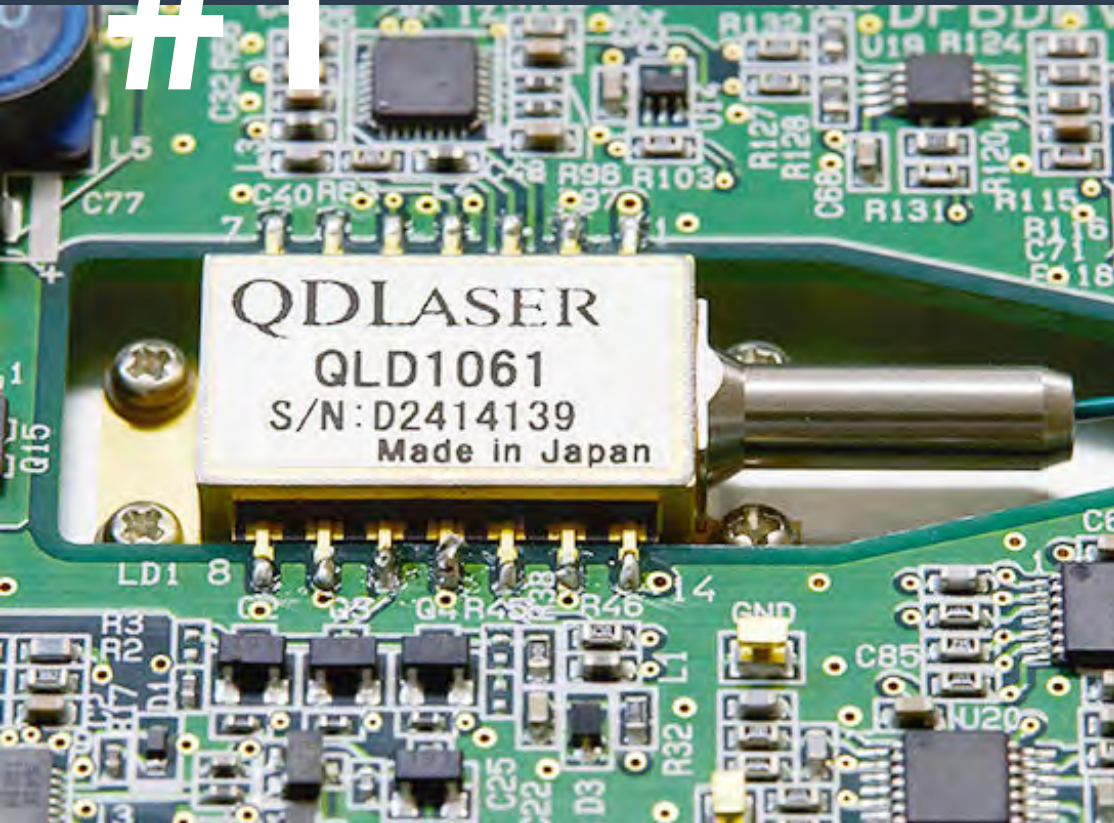

## DFB Laser

- Applications: Laser processing, measurement, and LiDAR.

Amplifies only the wavelength selected by the diffraction grating. **High output power, high stability, and low noise.** Provides the optimum wavelength for a wide range of applications and required performance.

- **Wavelength lineup of** 1030, 1053, 1064, 1080, 1120, 1180nm
- **Provided in 1nm unit**
- Non-heated processing is possible by **short-pulse operation in picoseconds.**
- **Highly stable and low noise** enables high-precision machining and measurement.
- Only a few companies worldwide can manufacture DFB lasers in this wavelength band.



# #2

## Compact Visible Laser Small Multi-Color Laser Light Source

- Application : Biomedical

Green, Yellow-Green, and Orange visible laser

The **patented technology** \* 1 realizes a **small device that other companies cannot manufacture.**

- Wavelength lineup of **532, 561, and 594nm.**
- Used for **"flow cytometer", "cell sorter", "laser microscope", "fundus diagnostics"** etc.
- Wavelength range where there is no direct emitting semiconductor lasers.
- Wavelength doubling with a nonlinear optical crystal.
- Unique semiconductor laser chip and wavelength conversion crystal package achieves miniaturization.
- **Low noise and excellent pulse stability.**

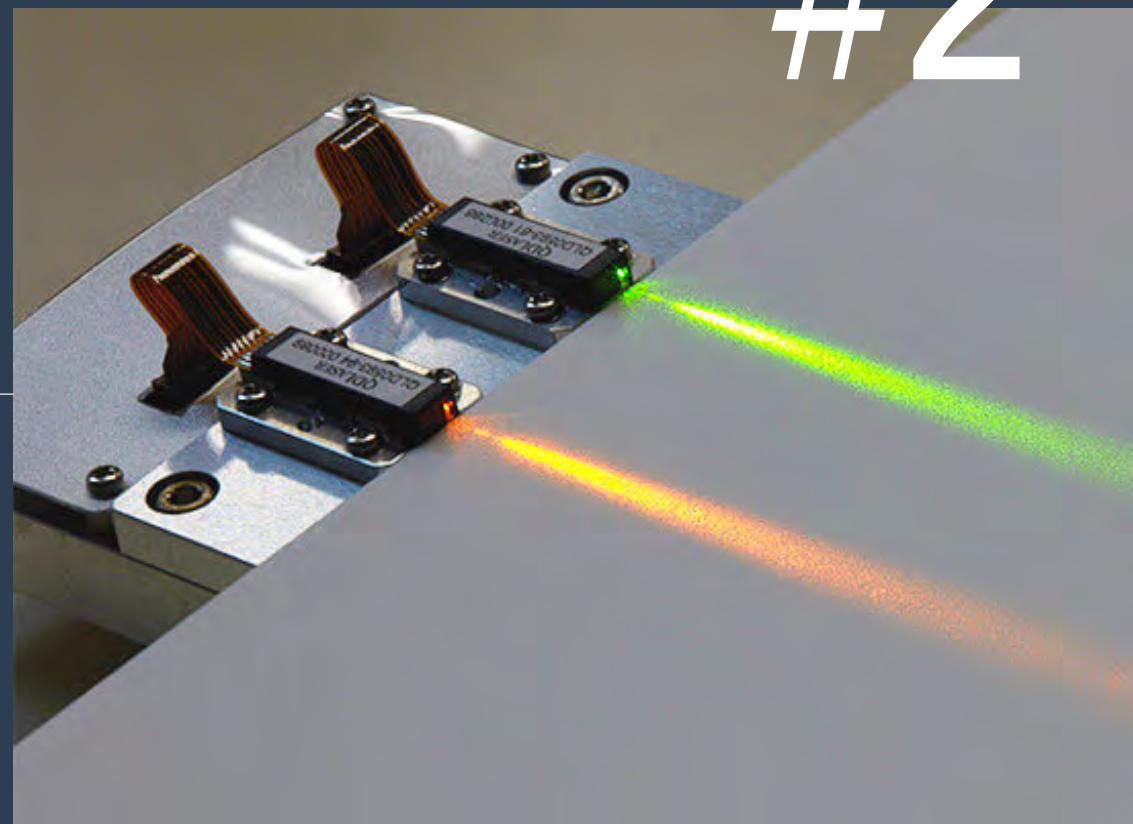

# #3

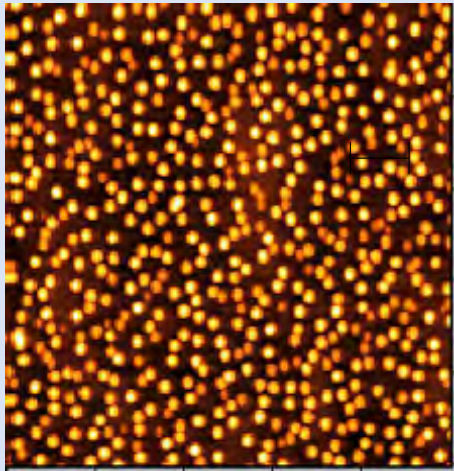

100 nm

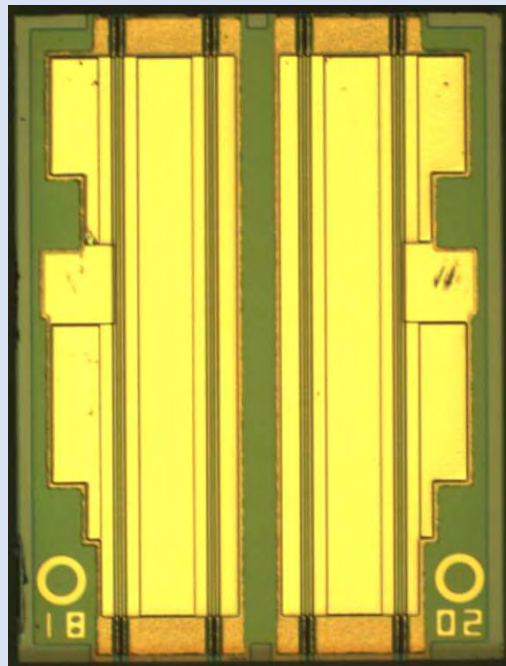

## Quantum-dot laser

- Application : Optical communication, LiDAR, and Silicon photonics.

**Mass-produced** by our world's only technology.

Achieved the **world's highest operating temperature** with excellent temperature stability at 1300nm.

- The wavelength lineup is **1200-1330nm**.
- **Silicon photonics (optical connector-chip communication, LiDAR)** is evolved by quantum dot laser.
- Can operate even in a high temperature environment of **150-200 ° C** . The operating limit temperature of a normal semiconductor laser is 80-100 ° C.
- Can be used in **high-temperature environments such as servers, wireless base stations, and automobiles**.
- **Excellent reflected return light resistance**, leading to miniaturization by eliminating isolators.

# QDLaser's World Only-One Mass-Production Technology of Quantum Dot Lasers

- Introduction of mass-production MBE (Molecular Beam Epitaxy) system
- Control of temperature, indium source supply, and arsenic pressure at each second.
- Material recipe and know-hows for optimum growth conditions with several-tens-of-years experience (secret internal techniques which are intentionally not patented)

Mass production MBE system

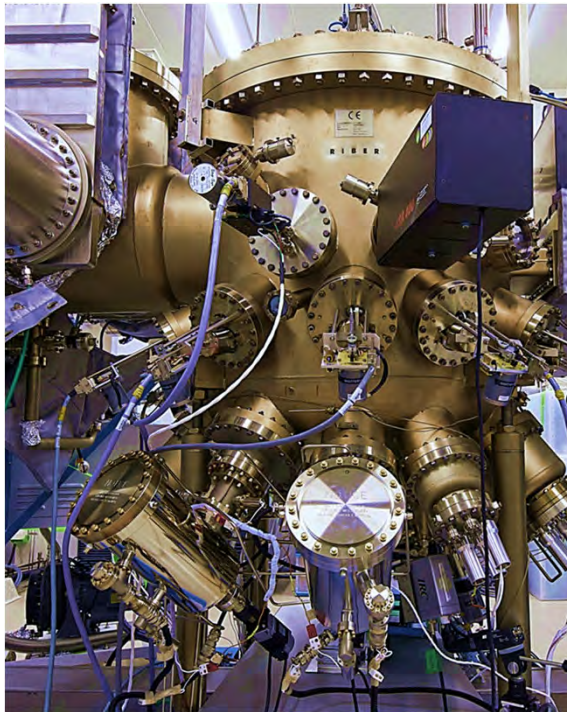

Growth sequence of quantum dots (illustration of side view)

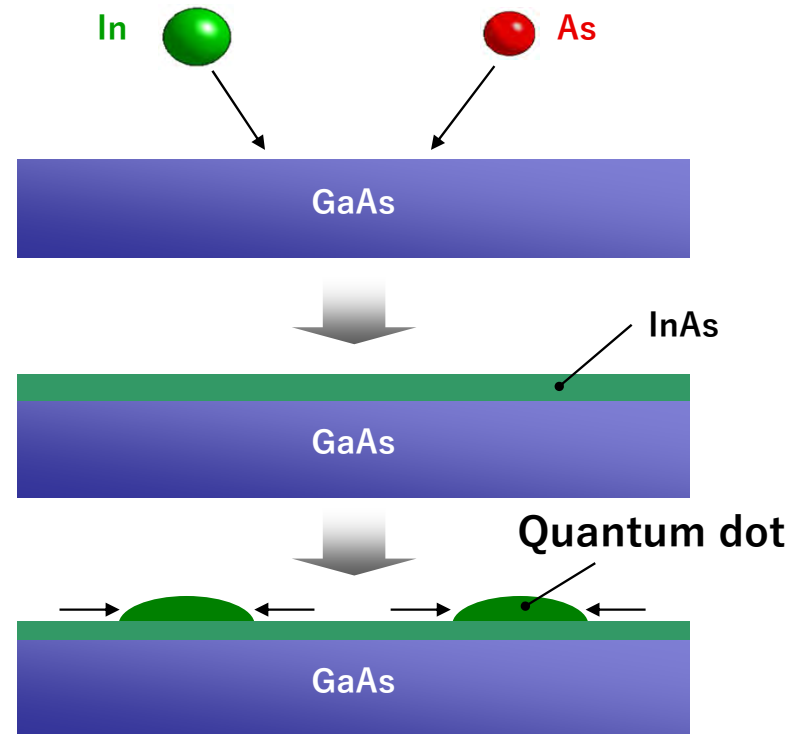

Atomic force microscope (top view) of quantum dots

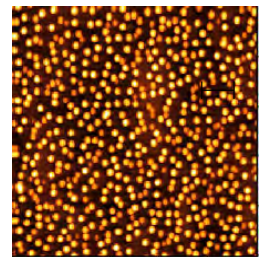

100 nm

# Tangible Silicon Photonics Market as Electronic / Optical Integrated Circuit Technology Platform

Received orders of 60,000-unit quantum dot lasers for mass production.

Customizing quantum dot lasers for Japan/US/EU silicon photonics vendors.

## Development and production

- 2010  
World's first mass production of quantum dot laser for optical communication
- 2012  
Started development of quantum dot laser for silicon photonics
- 2017  
Established mass production system of quantum dot lasers for silicon photonic: (supplied to AIO Core Co., Ltd.)
- 2019  
Our products installed in the "Ultra-thin connector integrated active optical module (I-PEX EOM)" developed by I-PEX
- 2023  
Received orders of 60,000pcs quantum dot lasers for mass production. Start shipment in May 2023.  
Working on joint development with silicon photonics vendors around the world.

## Quantum Dots

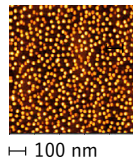

100Gbps optical transceiver with quantum dot lasers as light sources

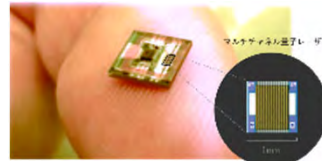

Optical Connector(EOM \*1,CPO \*2) : 8K-SHTV/ FA/ PCIe-Gen5/AI engine

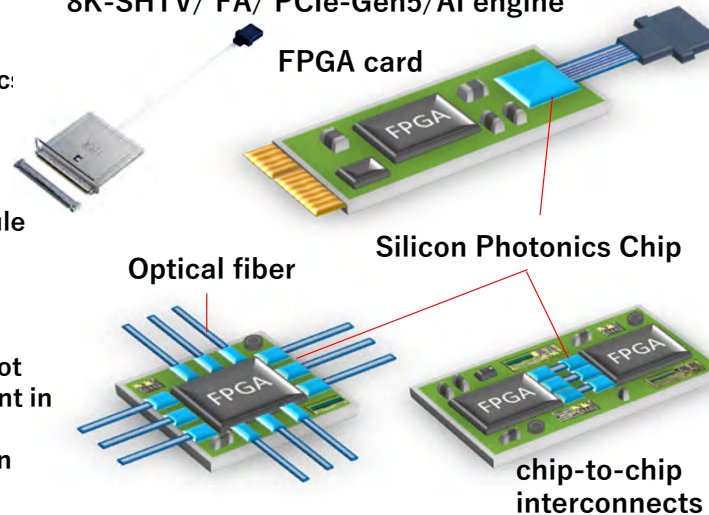

## Roadmap of mass production

### Phase 1: Lower production cost (2023-2024)

- 2023  
Started mass production of quantum dot lasers for AIO Core Co., Ltd.  
Lower cost of back-end process
- 2024  
Increase wafer diameter of quantum dot lasers

### Phase 2: Increase production capacity (2024-)

- 2024  
Place PO for mass production MBE machine #3
- 2025  
Investment for increasing production capacity to 1million pcs per year  
Install mass production MBE machine #3
- 2026  
Start mass production with two MBE machines

# IOCore™ with Quantum-Dot Laser Launched for Mass Production

- Installed in IOCore's silicon photonics chip for optical wiring "IOCore™" (commonly known as NPO \*1)
- Implementation of optical wiring technology contributes to dramatic improvements in computer information processing capabilities essential for AI and the Metaverse

100Gb/s Silicon photonics chip named IOCore™ of AIO Core Co., Ltd. with QD Laser's 4-channel quantum dot lasers

**Quantum dot laser**

**Quantum dots**

**Optical eye diagrams at 25Gbps**

ch1, ch2, ch3, ch4

25°C, 1.05°C

**Device to device**

**Board to board**

**LSI to LSI**

**Courtesy of AIO Core Co., Ltd.**  
**Note: Yellow squares show 100Gb/s transceiver Silicon chip**

Data center, Server, Super Computer



Demonstration of immersion cooling by AIO Core Co., Ltd.



5G/6G

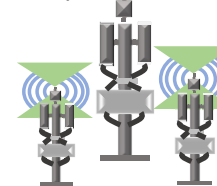

FA, Medical



Automatic Driving

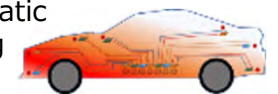

# #4

## High Power FP Laser

- Applications : Particle Counter, Leveler, Machine Vision and Factory LiDAR.

Highly reliable and high-quality CW / nanosecond pulse high power laser.

Providing services that meet customer requirements, such as usage conditions and small-quantity support.

- The wavelength lineup is **640-940nm**.
- CW and high-power nanosecond pulse drive for a wide range of sensor applications.
- Hearing customer needs on pulse, optical output, reliability, wavelength, and control method to propose optimal products and solution.
- **Small quantity production** possible.

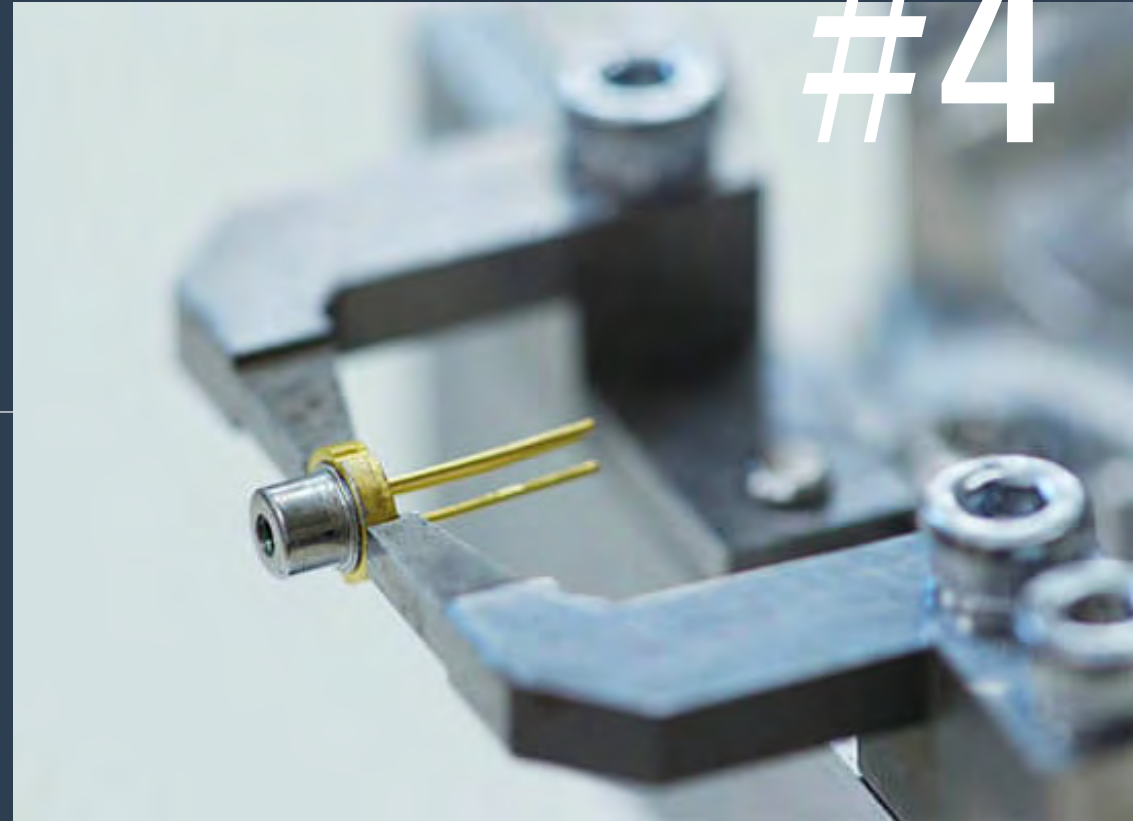

# Our Major Laser Device Products, Wavelengths, Features, and Uses

## Compact visible lasers

## High power laser

## DFB laser

## Quantum dot laser

### Products

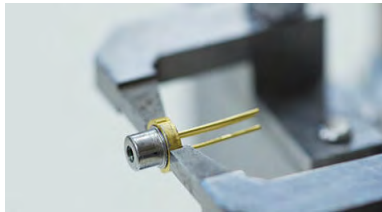
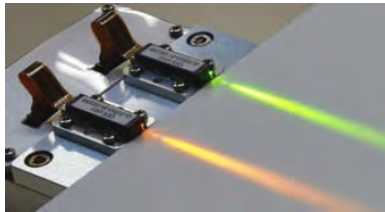

### Wavelength

532, 561, 594 nm

640-940nm

1030, 1053, 1064, 1080, 1120, 1180nm

1200-1330nm

1020-1120nm provided 1nm by 1nm

### Features

- Miniature size, low power consumption, stability, short pulse generation, and high-speed modulation, etc.
- World's first current injection yellow-green and orange lasers

- High power Fabry Perot laser
- Providing products and solutions according to applications.
- Supports various wavelengths, small quantities, and custom production.

- Precise control of wavelength with stable operation under continuous, nanosecond, and picosecond modes.
- High beam quality, small size, lightweight, high electricity-light conversion efficiency, and long life compared to existing solid-state lasers.
- Extensive product lineup that meets the various needs of customers.

- Quantum dots are used for the active layer (light-emitting part) of semiconductor lasers.
- Excellent temperature stability, high-temperature resistance, and low noise performance compared to existing semiconductor lasers.

### Use

Measurement

Bio.

Processing

Communication

Silicon photonics

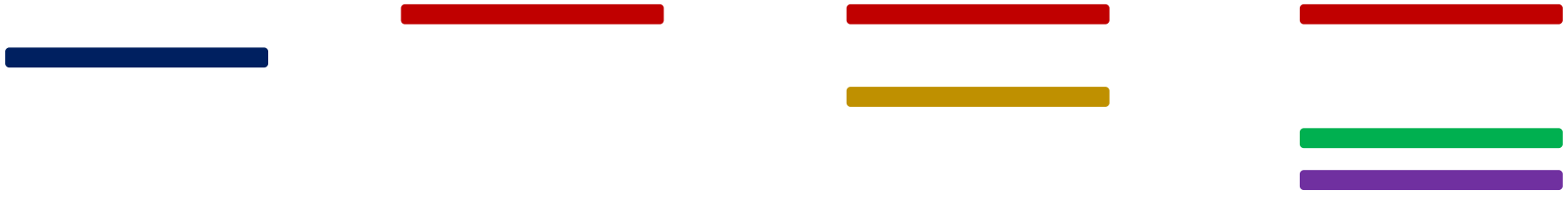

04

## Laser Retinal Projection

World's First Commercialization of Laser Retinal Projection Eyewear



# VISIRIUM TECHNOLOGY®

## Unique Laser Technology bringing Innovation to Vision

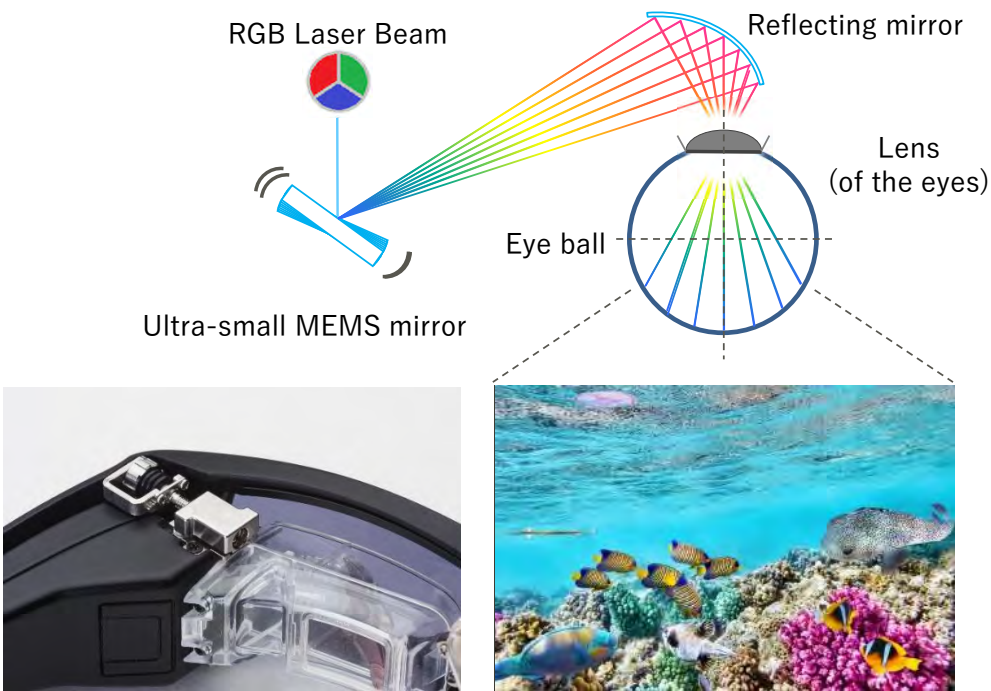

### Direct Image Projection onto Retina



#### Visual experience independent of the condition of your cornea or lens

You can recognize an image clearly even with myopia, hyperopia, astigmatism, or ametropia.

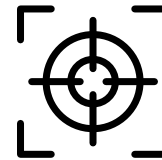

#### Free focus

The focus of both the landscape you see with the naked eye and the image projected by our glasses can be superimposed on the retina. This is a unique feature not found in other AR glasses.



#### Enables vision even in the periphery of the retina\*1

Since the image is in focus even over a wide area of the retina, we expect that it can also be effective for patients with retinopathy.

## Three Areas based on Retinal Projection Technology

---

Transforms  
“hard to see”  
to “visible”

**Low Vision Aid**

Extend the healthy  
lifespan of your vision

**Vision Health Care**

The power of  
“vision” broadens  
your world

**Augmented Vision**

# Low Vision Aids : Total Addressable Market (※Anterior eye disease patients only : Ametropia and corneal opacity)

JPY **900** bn (USD **8.6** bn) Market in Japan, U.S. and Europe

Plan to Expand into Other Countries like China further behind in Ophthalmic Technologies

## Low Vision Market



Estimated percentage of applicability (our estimate)\*3 × **11%** × Product Price per Unit (our assumption)\*6 × **JPY 200k (USD 1.9k)**

Total market size of advanced countries (Our estimate)  
**JPY 708.7 bn**  
**(USD 6.7 bn)**

## Senior Citizens Market

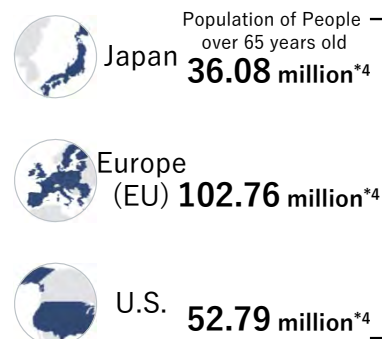

Estimated percentage of applicability (our estimate)\*5 × **1%** × Product Price per Unit (our assumption)\*6 × **JPY 100k (USD 950)**

Total market size of advanced countries (our estimate)  
**JPY 191.7 bn**  
**(USD 1.8 bn)**

**JPY 900** bn (USD **8.6** bn)

\*1: Japan Ophthalmologists Association "Social costs of visual impairment in Japan"

\*2: Calculated by multiplying the ratio of persons with low vision sourced from WHO "Visual Impairment and Blindness 2010" by the current population in each region (Europe: Eurostat "Population on 1 January", U.S.: United States Census Bureau "Annual Estimates of the Resident Population for the United States")

\*3: According to the survey by Santen Pharmaceuticals, the number of keratoconus patients in Japan is estimated to be 60,000 to 120,000; also, as the data on p.39 shows that the prevalence per 100,000 people of keratoconus is almost the same as that of corneal opacity, it is assumed that the number of corneal opacity patients in Japan is similar to that of keratoconus patients. Assuming the number of patients suffering from each of these diseases to be an intermediate value of 80,000, the total is calculated to be 160,000; then, we apply the estimated percentage of applicability of 11%, calculated by dividing 160,000 by the population of persons with low vision (1,450,000), to each country's population of low vision persons. This percentage only takes into account anterior eye diseases; therefore, if our product is also effective for patients with retinal disease, the estimated percentage of applicability is expected to increase.

\*4: Assuming that all the elderly aged 65 and over use near-sighted, presbyopic or bifocal glasses, we can estimate that each country's population aged 65 and over can be the potential population of persons with gap vision (Japan: Statistics Bureau of Japan "Population Estimates May 2020", EU: Eurostat "Population on 1 January by broad age group and sex", U.S.: United States Census Bureau "Population by Age and Sex: 2019").

\*5: Due to the products' similarity in characteristics to hearing aids (used by the elderly on a daily basis, wearable equipment, sold at glasses stores, etc.), the hearing aid market is used as a reference to estimate the percentage of applicability. Given that the number of hearing aids shipped in Japan in 2017 numbered 562,747 (Japan Hearing Instruments Manufacturers Association "2018 Shipment Volume of Hearing Aids"), this number divided by the number of elderly people in Japan will give us an estimate that 1.7% of the elderly purchased a hearing aid, which we then adjust conservatively to assume an estimated percentage of applicability of 1.0% which can then be applied to each country's population of gap vision persons.

\*6: Expected price per unit after the mass production is realized.



# World's First Laser Retinal Projection Eyewear

## In the Low Vision Aid Space where Innovation has been Minimal, Laser Technology makes a Breakthrough

# 250mn people

### with Low Vision Globally\*1

Currently they use magnifying glasses, video magnifiers, and telescopes daily. These tools are limited in use, have operational, issues and are not suitable for all users.

Here, we will make a breakthrough with our laser retinal projection technology.

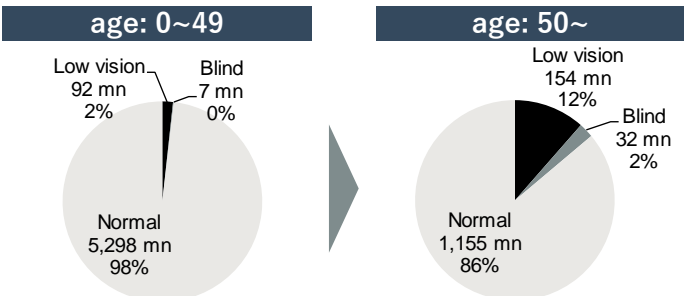

GLOBAL DATA ON VISUAL IMPAIRMENTS 2010, WHO



**“Papa, you have grown old, I can see the wrinkles on your forehead.”\*2**



\*1: WHO Definition: Low vision is defined as the best-corrected visual acuity of less than 0.3 in the better-seeing eye. Blindness is defined as the best-corrected visual acuity of less than 0.05 in the better-seeing eye.

\*2: Translated from German

# RETISSA Series : Eyewear Products

---

## Continued sales of RETISSA Display II, expanded to new products with wider FoV



### RETISSA Display

- Announced in January 2018 and released in July 2018 as the first commercialization of VISIRIUM technology.
- The world's first commercial launch of a wearable display with a built-in retinal scanning projector using semiconductor lasers.



### RETISSA Medical

- Obtained manufacturing and marketing approval in January 2020 as a medical device with the laser retinal projection technology.
- Corrects low vision due to irregular astigmatism by projecting images of the built-in camera (clinical trial completed in JAPAN, October 2018)
- Conducted a clinical trial for corneal opacification in Europe and confirmed its efficacy.



### RETISSA Display II

- Wearable display equipped with the 2nd generation VISIRIUM technology, announced in December 2019 and released in March 2020.
- With improved image quality, reduced size and weight, reduced power consumption, and improved usability.
- Optional camera RD2CAM released in August 2021



## RETISSA Series Development Status: New Product with wider FoV

Released three products equipped with the 3rd generation VISIRIUM technology with wider viewing angle as the main feature.

It can deliver clear and bright images to the peripheral area of the retina, which is a major technological breakthrough in the field of Low Vision Aid.

### 1st/2nd generation

Horizontal viewing angle of 26 degrees

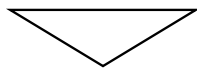

### 3<sup>rd</sup> generation

Horizontal viewing angle of 60 degrees



# RETISSA ON HAND

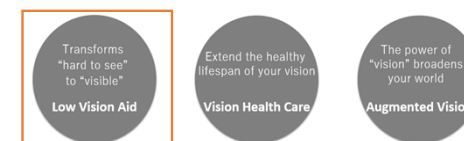

## Released in March 2023 as a "retinal projection video magnifier"

- Visual assistance with up to 7x digital zoom and wide viewing angle retinal projection.
- All-in-one design with built-in battery, portable as well as desktop use.
- Sales are being expanded through general domestic agents in the government and welfare fields.  
20 local governments provide benefits as the welfare equipment of daily necessities as of February 2024.
- Gradual introduction to public facilities such as libraries and museums as devices that comply with the Reading Barrier Free Act in JAPAN.
- Collaboration with TRC Library Service Inc. working on contracted operation of 562 public libraries and 19 museums, etc.



# RETISSA NEOVIEWER (RNV)



## Released in March 2023 as a bundle "DSC-HX99 RNV kit" with a Sony compact digital camera

- Products from the "With My Eyes" project that changes the vision of the low vision into visible.
- Providing the enjoyment of shooting with a high-performance camera equipped with a high-magnification (up to 28x) optical zoom.
- Positioned as an inclusive design to enhance accessibility.
- Received VGP2023 Summer special award and Good Design Best 100.<sup>\*1</sup>
- Launched in Japan and the US at the special price. Rental programs are also offered.

\*1





# Sales expansion for products in the Low Vision Aid field

---

## Implement sales expansion activities that match the characteristics of each product in cooperation with partners

### Awareness

- Regularly providing updates through official SNS (X and Instagram.)
- The products and technology were featured in TV programs (NHK Education etc.)
- Participation in the events organized by Arts Council Tokyo (for art promotion) and Team Beyond (for para-sports.)
- Released a development story of DSC-HX99 RNV kit and a new episode (#4) of With My Eyes.

### Touch-point

- Exhibitions and hands-on events for low-vision
- Sight World (November 1st to 3rd), exhibited in collaboration with Sony
- Launched a rental program of DSC-HX99 RNV kit on Rentio. (from Oct. 2<sup>nd</sup>)

### Reimbursement

- Steadily increasing the number of approvals/accreditation as daily life tools like enlarged reading devices by local governments (13 cities to 20 cities.)
- RD2 + CAM has been sold as a subsidized device in South Korea.
- As part of the With My Eyes project, a special price was realized by the support of Sony. (RNV)

**In addition to the above, business development efforts are carried out in the US and China to expand market access.**

# Activities to expand sales of products in the Low Vision Aid field

## Added English-language content.



RETISSA official Instagram (Japanese)  
[https://www.instagram.com/retissa\\_official/](https://www.instagram.com/retissa_official/)

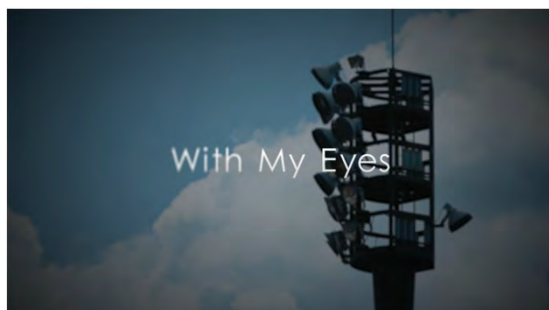

With My Eyes 4 (Japanese Ver.)  
<https://www.youtube.com/watch?v=0jAH9BP8Vc&t=17s>

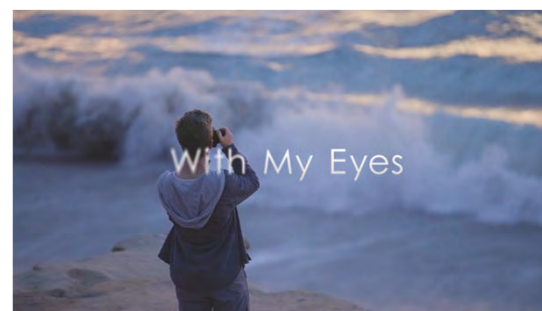

With My Eyes (Global Episode)  
Visions Captured: Sight Without Borders  
<https://youtu.be/RCKCBF6PMuM>

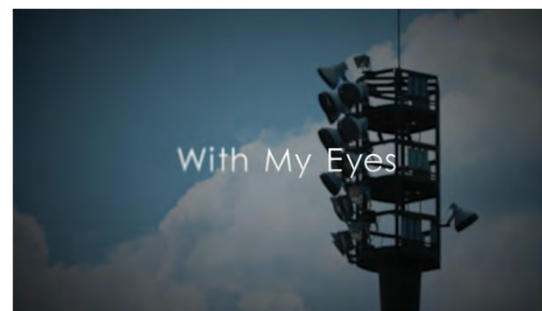

With My Eyes 4 (English Ver.)  
Experiencing and Capturing Car Racing with the Five Senses  
<https://youtu.be/hK-WWgP83v8>

# RETISSA MEOCHECK



## Full-fledged launch of vision healthcare field with eye health check equipment in February 2023

- Aiming for early awareness of eye diseases such as glaucoma, which is the leading cause of blindness in Japan and visual field abnormalities.
- Self-check method that can check vision in about 1 minute per eye to show eye age score.
- In addition to equipment sales through the Nihon Ganka Iryocenter Co., Ltd. (agency), we are launching a service business.
- Nihon Kotsu and Hiroshima Tsubame Kotsu have introduced vision health checks for employees.



# Launch of Vision Health Care field



## The introduction of Vision health check service is steadily expanding.

- In addition to a mass check-up alongside regular health screenings, daily on-site checks at an office have been also evaluated.
- Expanding to other transportation providers and tapping into the corporate demand for employee health management.

Tsubame Kotsu (Hiroshima)



In addition to mass check-up for 300 employees, the device has been located at the office to provide frequent self-check opportunities.

Nihon Kotsu (Tokyo)



Eye health checks during regular health screenings for approximately 3,000 employees at every locations in Tokyo, and more.



# Initiatives in the Expanding Vision Health Care Field

Using eye health check device “MEOCHECK” commercialized in FY2023-Q1, and fundus imaging device SLO under development.

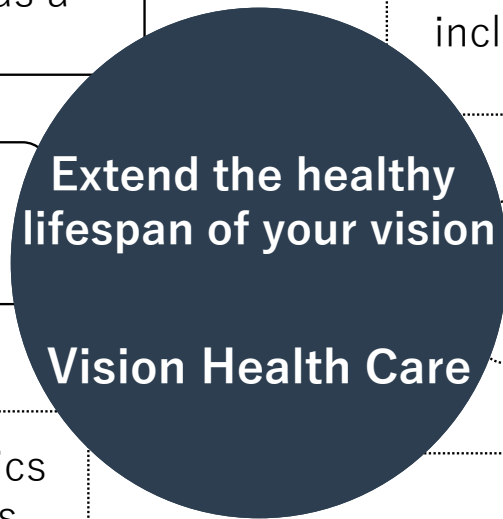

Eye health check service for the transportation industry, such as a fleet companies

Setup of a health check corner, including corporate employee health management

Collaborative research/clinical research with medical universities, such as Tohoku Univ.

Launch of compact and inexpensive ophthalmic medical equipment

Introduction to ophthalmology clinics and medical examination facilities

Telemedicine  
Personal Health Record

## Elemental technology development for next-generation laser eyewear



Continuing technical development aimed at the ultimate smart glasses as a commissioned development. Under joint development with many partners such as TDK and mobile device manufacturers.

Compact, low-power integrated scanning light source as a standardized module

Unprecedented High image quality (1080P) by direct retinal projection

Eye tracking drive system



Prototypes exhibited at CEATEC 2023 (images by TDK)  
\*This product is under development, and the timing and price of commercialization are to be determined.

05

ESG Initiatives

# Business Development from an ESG Perspective

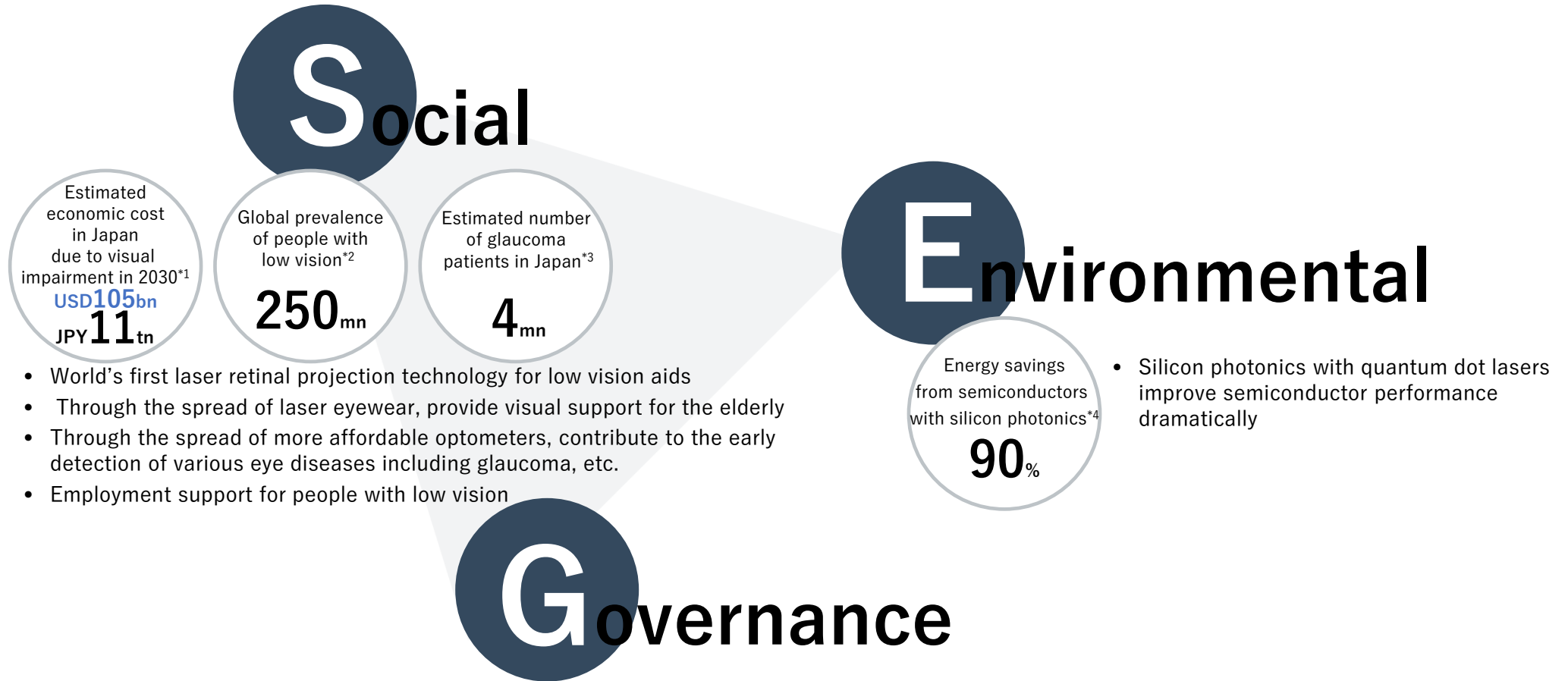

\*1: Japan Ophthalmologists Association "Economic Cost of Visual Impairment in Japan" and "Prevalence of Visual Impairment in the Adult Japanese Population by Cause and Severity and Future Projections"  
 Economic cost = Direct health costs + Other financial costs + monetary converted number of loss of well-being from visual impairment (measured in disability-adjusted life years (DALYs))

\*2: WHO "GLOBAL DATA ON VISUAL IMPAIRMENTS 2010"

\*3: Santen Pharmaceutical "Annual Report 2017"

\*4: Target numbers in "Development of Technologies for Super Energy-Efficient Optical Electronics Implementation Systems" Promoted by METI, The Institute of Electronics, Information and Communication Engineers "Opt-Electronics Packaging Technology for Silicon Photonics"



# With My Eyes project

#1 Photographs by low vision people.

<https://www.youtube.com/watch?v=p5blfs94Oys>

#2 Let's go and see the invisible world.

[https://www.youtube.com/watch?v=ZM52dax\\_5yc](https://www.youtube.com/watch?v=ZM52dax_5yc)

#3 - Discovering a World of My Own -

<https://www.youtube.com/watch?v=lp6a5h6UfxA&t=37s>

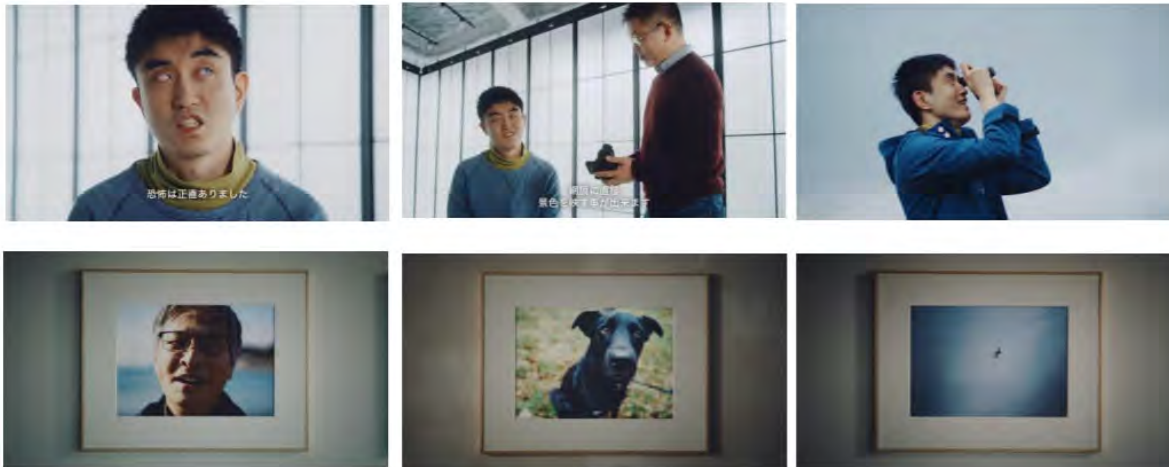

## With My Eyes #4 Toyota Mobility Foundation

### Watching and capturing car race with all five senses (2023/10/17)

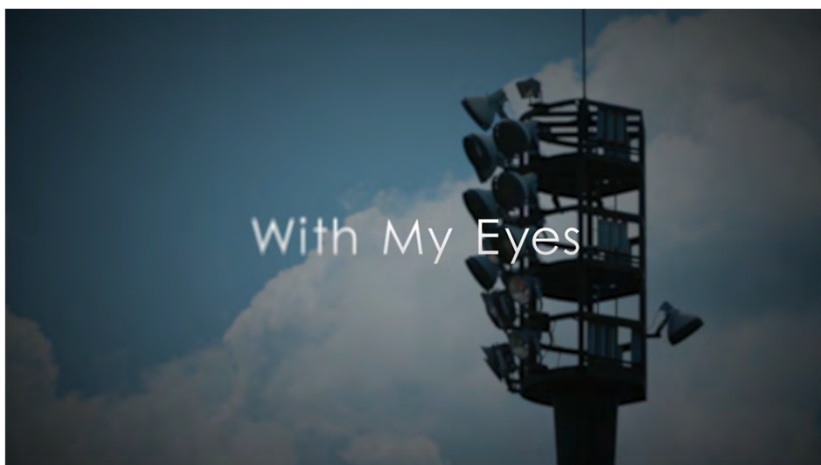

#### ■ Overview of the documentary movie

On September 2nd and 3rd, 2023, individuals with low vision attended and photographed the racing event "ENEOS Super Endurance Series 2023 Supported by BRIDGESTONE Round 5" held at Mobility Resort Motegi. This was part of a demonstration experiment conducted under the theme "Mobility for All 2023" of the "Make a Move Project," an idea contest organized by the Toyota Mobility Foundation.

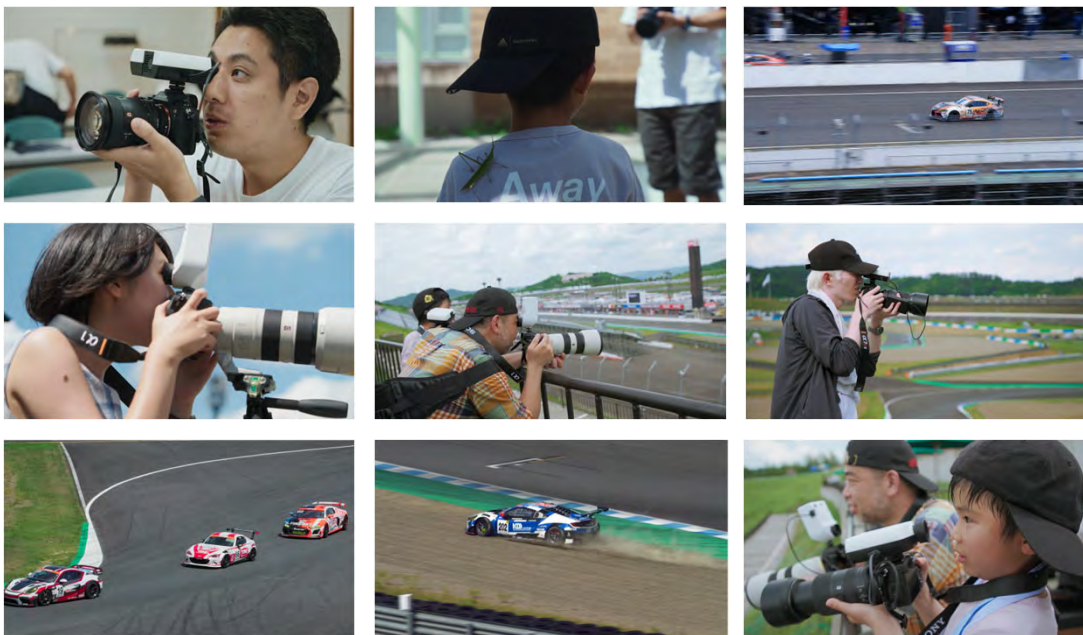

# Company Profile

## Spin-off Venture from Fujitsu

## Tier 1 Medical Companies such as Nikon/Santen joined as Shareholders

Company Name	QD Laser, Inc.
Foundation	April 24, 2006
Fiscal year-ended	March 31
Representative	Mitsuru Sugawara, President and CEO
Location	Headquarter: 1-1 Minamiwatarida-cho, Kawasaki-ku, Kawasaki-shi, Kanagawa
Number of Persons*1	44
Business	Planning, design, development, production and sales of semiconductor laser and its application products
Licenses	<ul style="list-style-type: none"><li>• Class II Marketing License for Medical Devices</li><li>• Registration of medical equipment manufacturer</li><li>• ISO 9001</li><li>• EN ISO 13485</li></ul>



**Science and Technology  
Award from the Minister  
of MEXT**

**Prime Minister's Honorary  
Award for Achievement in  
Industry-Academia-  
Governmental Collaboration**

- Graduated from The University of Tokyo;  
Doctor of Engineering
- 1984: Graduated with a master's degree in Physical  
Engineering from the Department of Applied Physics,  
School of Engineering, University of Tokyo; joined  
Fujitsu Laboratory Ltd.
- 1995: Assumed the role of Senior Researcher at Optical  
Semiconductor Device Laboratory, Fujitsu Laboratory  
Ltd.; obtained degree in Eng. from The University of  
Tokyo
- 2004: Assumed the role of non-tenured professor at the  
Institute of Industrial Science, University of Tokyo
- 2005: Assumed the role of Deputy Head of  
Nanotechnology Research Center, Fujitsu Laboratory  
Ltd.
- 2006: Launched QD Laser Inc.; assumed the role of  
President and CEO

# Laser Retinal Projection: Diseases and Applicable Rate

Parts of Eye	Major diseases	# of patients per 100k people*1	Total per eye part*1	Possible Efficacy*2	Estimated applicability %*3	Future Outlook		
Anterior eye	Cornea	Corneal angiogenesis	4,000	4,104	◎	Effective on astigmatism and moderate opacity	50%	<ul style="list-style-type: none"> <li>• May not be applicable in cases of severe opacity</li> <li>• Focused on obtaining the approvals to marketing medical devices by targeting diseases for which high efficacy can be expected.</li> <li>• Plan to expand the scope of application with RDII and RDIII on page 25 and the wide-angle viewfinder on page 27.</li> </ul>
		Keratoconus	54					
		Corneal opacity	50					
	Crystalline lens	Cataract	47,800	52,900	◎	Effective on near/far-sightedness, astigmatism, opacity, etc. and as the technology does not depend on the function of the crystalline lens		
		Aphakia	5,100					
		Phacocele	<50					
	Uvea	Uveitis	714	714	△	Effective on astigmatism developed as a complication		
Choroidal neovascularization		<50						
Vitreum	Vitreous opacity	NA	-	○	Effective on low to moderate opacity	20%		
Retina	Epiretinal membrane	28,900	55,614	○	Enlargement and black and white inversion features are effective on macular diseases	30%	<ul style="list-style-type: none"> <li>• Adaptable to central scotoma by changing the projection position and increasing magnification</li> <li>• May not be applicable in cases with severe symptoms</li> </ul>	
	Lattice degeneration of retina	10,600						
	Hypertensive retinopathy	9,100			Some efficacy is seen in cases where anterior eye disease is also present			
	Age-related maculopathy	3,900						
	Diabetic retinopathy	3,114			AE camera feature is exceptionally effective on photophobia, night blindness, etc.			
	Retinitis pigmentosa	<50						
Optic nerve	Glaucoma	3,550	3,865	△	Image downsizing feature is effective on tunnel vision	10%		
	Optic nerve head drusen	200						
	Optic neuritis	115						
Other	High myopia	3,000	3,000	◎	Exceptionally effective	50%	<ul style="list-style-type: none"> <li>• Can improve by processing images taken by camera</li> </ul>	
	Color amblyopia, color blindness	2,500	2,500	○	-	20%		

\*1: These numbers were calculated by research company Lampe & Company in a report we commissioned with reference to scholarly papers published by governments and research institutions from each country. Figures for "# of patients per 100k people" and "Total per eye part" reflect the general research conducted across several jurisdictions and are not necessarily indicative of the number of potential cases in the markets in which we currently operate.

\*2: Based on our assumptions

\*3: Evaluated the "expected efficacy" using a scale: ◎ = 40-50%, ○ = 20-30% and △ = 5-10%.

# Terminology

---

<b>Semiconductor laser</b>	A compact device with an approximate length of 1mm that causes laser oscillation by passing an electric current to a semiconductor. In comparison with a solid-state laser or gas laser, more micro-miniature in size; higher speed modulation characteristics up to 10GHz; higher photoelectric conversion efficiency achieving several tens of percent and better controllability of wavelength, among other things. Became widely used in the 1980s as a light source for communication systems and optical recording media, such as CDs and DVDs, etc.
<b>Quantum dot laser (QDL)</b>	A semiconductor laser using a quantum-dot structure comprising nanocrystalline semiconductors in its active layer. QD Laser is the only firm in the world to mass-produce QDLs for optical communications and silicon photonics. In comparison to existing semiconductor lasers, it is superior in temperature stability, high-temperature endurance and low-noise properties.
<b>DFB laser</b>	Distributed Feedback Laser: QD Laser's DFB laser is equipped with a diffraction grating which enables laser oscillation at a single wavelength. It is suitable for applications where the light output needs to be concentrated into a narrow wavelength range, such as the seed light of a fiber laser.
<b>Silicon photonics</b>	A technology which integrates an optical circuit with a silicon electronic circuit that has signal processing and memory functions, thus enabling a breakthrough in the processing capacity limitation of the conventional electronic circuit system (achieving 100 times faster processing speed and lower power consumption) and high-capacity data transmission between LSI chips (10Tb/s).
<b>VISIRIUM technology</b>	A technology that projects images onto the retina using precise optical systems, creating different colors flexibly from the three primary laser light colors - red, green and blue.
<b>Diffraction grating technology</b>	A technology that freely and precisely controls the wavelength of semiconductor lasers to fit into various applications by forming periodic irregularities inside the laser.
<b>Ultrashort pulse</b>	A laser with a very short pulse width (duration). It is used for microfabrication and other processes as it can prevent shape distortion due to thermal effects.
<b>Retinal projection</b>	To project images onto the retina
<b>Simple perimeter</b>	A device to assess the visual field of human eyes
<b>CE marking</b>	A certification mark that indicates conformity with standards required to be met by products exported to the EU. The CE mark is granted when a product meets standards in all EU member states.
<b>Flow cytometer</b>	A device capable of measuring certain properties of cells. By irradiating a cell suspension in a tube with a laser beam, it can measure the number and size of a large volume of cells over a short period of time using fluorescence and scattered light parameters. It is used in various fields including molecular biology, pathology, immunology, plant biology and marine biology.
<b>LiDAR</b>	LiDAR (Light Detection and Ranging) is a technology which irradiates an object and uses a light sensor to detect the reflection to measure the distance. It is expected to be used in autonomous driving systems in the future.
<b>Heads-up Display</b>	A technology that projects information and images onto various surfaces, such as glass, within the field of view. It is expected one day to project necessary information for drivers onto the windshield and the like.

## **Caution When Handling This Document**

---

- The materials and information provided in this presentation include forward-looking statements.
- These statements are based on expectations, forecasts and risk assumptions as of this presentation's publishing, and contain uncertainties that could lead to results that are substantially different from these statements.
- These risks and uncertainties are present in any transaction, and are applicable to general industry and market conditions as well as general domestic and international economic conditions, including fluctuations in interest rates and currency exchange rates.
- Note that QD Laser does not bear any duty to update or revise forward-looking statements provided in this document, even if new information comes to light or future events occur.